

CATÁLOGO





Elegancia y diseño para una amplia colección que cubre los diferentes elementos que componen los espacios de trabajo, despachos operacionales y direccionales, mesas de reuniones, armarios y recepciones permitiendo así configurar un espacio de trabajo organizado, flexible y eficiente.

Ofitres ofrece una selección de acabados moderna, contemporánea y exclusivos, que permite diseñar espacios únicos, con un añadido de diseño y al corriente de las tendencias. Cada colección permite combinar añadidos de tecnología actual, facilitando el confort y la practicidad de cada espacio.

Elegance and design in several collections, covering the different elements of operational and directional workspaces, meeting tables, cabinets and receptions. Allowing thus the configuration of organized, flexible and efficient work spaces.

Ofitres offers a selection of modern, contemporary and exclusive finishes, Luxe by Alvic, which allows to design unique spaces, with an added touch of trendy design.

Our collections allow to incorporate the latest technology in electrical fittings, providing comfort and efficiency in each space.

Élégance et design dans différentes collections, couvrant les éléments des espaces de travail opérationnels et directionnels, des tables de réunion, des armoires et des réceptions. Permettant ainsi de configurer des espaces de travail organisés, flexibles et efficaces.

Ofitres propose une sélection de finitions modernes, contemporaines et exclusives, Luxe by Alvic, qui permet de concevoir des espaces uniques, avec un design ajouté et en phase avec les tendances actuelles.

Chaque collection permet d'ajouter les derniers compléments électriques facilitant le confort et la praticité de chaque espace.



ÍNDICE

OXYGEN	04 33
I.POP O.POP	34 85
EXTREM	86 109
LOG-IN ELEVABLE	110 117
LOG-IN	118 131
NOVA	132 143
NEW PANO	144 159
PREMIER	160 171
COLECTIVIDADES	172 181
AVANT	182 205
M. NEW PANO	206 215
SISTEMAS DE ARCHIVO	216 237



OXYGEN

EXECUTIVE

OXYGEN ES UNA GAMA DIRECCIONAL ÁMPLIA, CON UN AÑADIDO DE DISEÑO Y ACABADOS EXCLUSIVOS DE GRAN CALIDAD QUE OFRECE LA POSIBILIDAD DE CREAR ESPACIOS ÚNICOS CUIDANDO AL MÁXIMO LOS DETALLES.

OXYGEN IS A DIRECTIONAL RANGE, WITH AN ADDED VALUE IN DESIGN AND EXCLUSIVE FINISHES OF GREAT QUALITY, THAT OFFERS THE POSSIBILITY OF CREATING UNIQUE SPACES TAKING CARE OF ALL THE DETAILS.

OXYGEN EST UNE GAMME DIRECTIONNELLE, AVEC UN PLUS EN DESIGN ET DES FINITIONS EXCLUSIVES DE GRANDE QUALITÉ, QUI OFFRE LA POSSIBILITÉ DE CRÉER DES ESPACES UNIQUES EN PRENANT SOIN DES DÉTAILS.

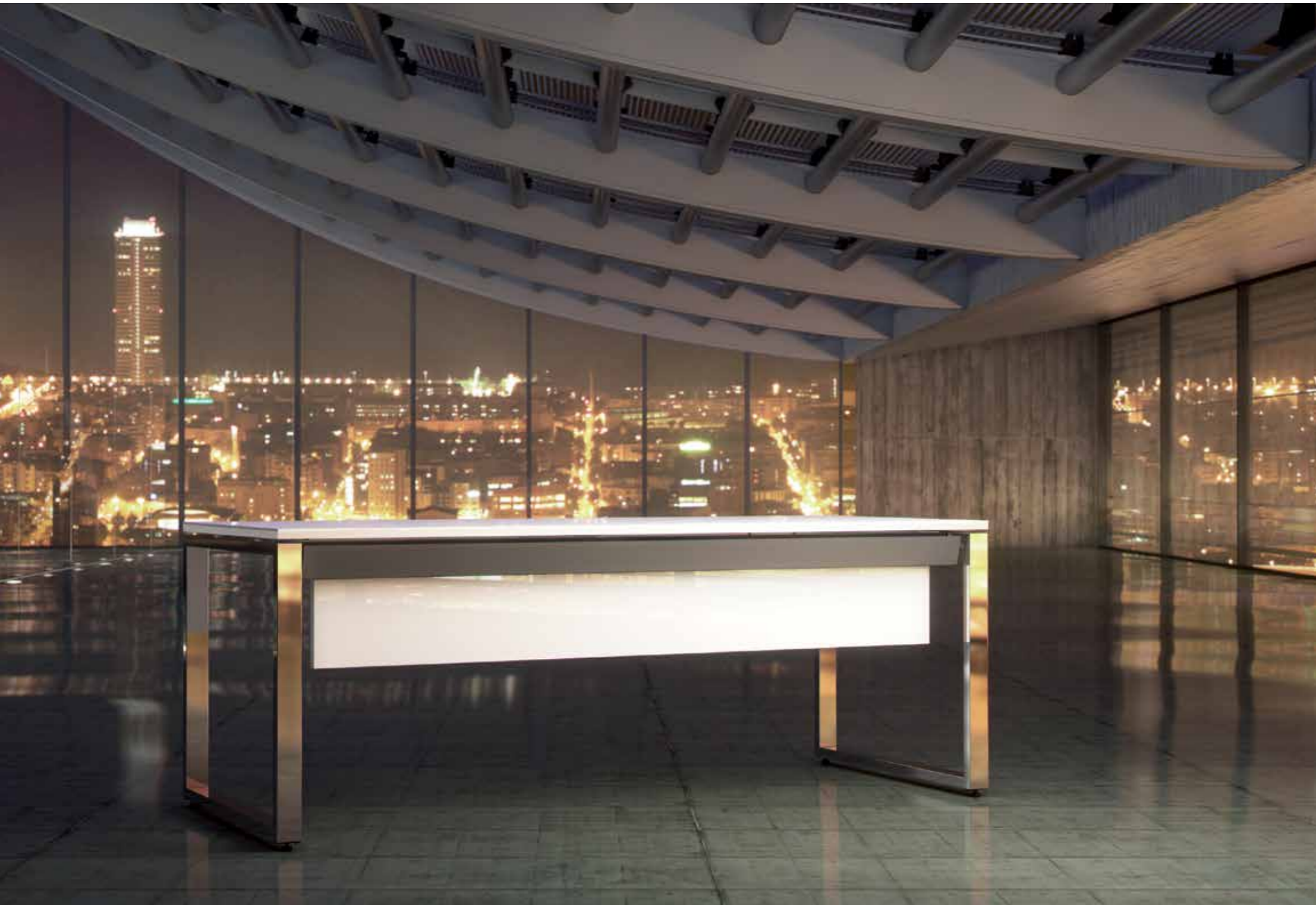

DESIGN: (LUXE) BLANCO / WHITE / BLANC.



DESIGN: (LUXE) BLANCO / WHITE / BLANC.





DESIGN: (LUXE) CUZCO - ORO.



DESIGN: (LUXE) CUZCO - ORO.





DESIGN: (CRISTAL / VIDRE / GLASS / VERRE) NEGRO, BLACK, NOIR. (LUXE) BLANCO, WHITE, BLANC.



DESIGN: (LUXE) BLANCO, WHITE, BLANC. (LUXE) ANTRACITA, GRAPHITE, ANTHRACITE.

LA COMBINACIÓN DEL CRISTAL CON LAS ESTRUCTURAS CROMADAS BRINDAN UNA IMÁGEN EXCLUSIVA Y DE ALTA CÁLIDAD.
 COMBINING GLASS DESKTOPS WITH CHROMED STRUCTURES, PROVIDES AN EXCLUSIVE AND HIGH QUALITY RESULT.
 LA COMBINAISON DE BUREAUX EN VERRE ET DE STRUCTURES CHROMÉES DONNE UN RÉSULTAT EXCLUSIF ET DE GRANDE QUALITÉ.





DESIGN: (LUXE) ANTRACITA METALDECO / ANTHRACITE METALDECO.



DESIGN:(LUXE) NEGRO / BLACK / NOIR.

LÍNEAS FLUIDAS Y LIGERAS, SENSACIONES TÁCTILES Y VISUALES.
UN BALANCE PERFECTO ENTRE PERCEPCIÓN, FORMA Y FUNCIONALIDAD.

FLUID AND LIGHT LINES, TACTILE AND VISUAL SENSATIONS. A PERFECT
BALANCE BETWEEN PERCEPTION, SHAPE AND FUNCTIONALITY.

DES LIGNES FLUIDES ET LÉGÈRES, DES SENSATIONS TACTILES
ET VISUELLES. UN ÉQUILIBRE PARFAIT ENTRE PERCEPTION, FORME ET
FONCTIONNALITÉ.



DESIGN: (LUXE) BLANCO / WHITE / BLANC. (LUXE) NEGRO / BLACK / NOIR.



DESIGN: (LUXE) BLANCO / WHITE / BLANC. (LUXE) NEGRO / BLACK / NOIR.



DESIGN: (LUXE) BLANCO / WHITE / BLANC.



POSIBILIDAD DE INTEGRAR UNA SOFISTICADA BANDEJA PASACABLES HORIZONTAL DE GRAN CAPACIDAD Y DE SENCILLA INSTALACIÓN COMO ELEMENTO DE ELECTRIFICACIÓN QUE FACILITA LA GESTIÓN DEL CABLEADO.

POSSIBILITY OF INTEGRATING A SOPHISTICATED HORIZONTAL CABLE TRAY OF GREAT CAPACITY AND EASY TO ASSEMBLE AS ELEMENT OF ELECTRIFICATION THAT FACILITATES THE WIRING MANAGEMENT SYSTEM.

POSSIBILITÉ D'INTÉGRER UNE GOULOTTE PASACABLES HORIZONTALE D'UNE GRANDE CAPACITÉ ET D'INSTALLATION SIMPLE COMME L'ÉLÉMENT D'ÉLECTRIFICATION QUI FACILITE LA GESTION DU CÂBLAGE.

ELEVANDO EL VALOR ERGONÓMICO. UNA SOLUCIÓN CONTEMPORÁNEA TECNOLÓGICAMENTE AVANZADA QUE OFRECE UN ALTO NIVEL DE FUNCIONALIDAD Y ESTILISMO.

RAISING THE ERGONOMIC VALUE, A TECHNOLOGICALLY ADVANCED CONTEMPORARY SOLUTION THAT OFFERS A HIGH LEVEL OF FUNCTIONALITY AND FASHION DESIGN.

EN ÉLEVANT LA VALEUR ERGONOMIQUE. UNE SOLUTION CONTEMPORAINE TECHNOLOGIQUEMENT AVANCÉE QUI OFFRE UN HAUT NIVEAU DE FONCTIONNALITÉ ET DE STYLISME.





NUEVA GENERACIÓN DE ACCESORIOS DEDICADA AL ENTORNO DE OFICINA DIRECCIONAL QUE FACILITA EL ACCESO A LA ELECTRIFICACIÓN Y DATOS.

NEW GENERATION OF COMPLEMENTS DEDICATED TO THE EXECUTIVE ENVIRONMENT THAT FACILITATES THE ELECTRIFICATION AND INFORMATION.

NOUVELLE GÉNÉRATION D'ACCESSOIRES DÉDIÉE À L'ENVIRONNEMENT DE BUREAU DIRECTIONNEL QUI FACILITE L'ACCÈS À L'ÉLECTRIFICATION ET AUX DONNÉES

DISEÑO, EFICACIA Y BIENESTAR EN EL PUESTO DE TRABAJO. ATRACTIVA CREDENZA MULTIFUNCIONAL CON GAMA DE COMPLEMENTOS QUE LE AYUDAN A ORGANIZAR SU ESPACIO.

DESING, EFFICIENCY AND WELLBEING IN THE WORKING PLACE. ATTRACTIVE MULTIFUNCTIONAL CREDENZA WITH RANGE OF COMPLEMENTS THAT HELP TO ORGANIZE YOUR SPACE.

DESSIN, EFFICACITÉ ET BIEN-ÊTRE DANS LE POSTE DE TRAVAIL. CREDENZA ATTRACTIVE ET MULTIFONCTIONNELLE AVEC GAMME DE COMPLÉMENTS QUI L'AIDENT À ORGANISER SON ESPACE.



PUERTAS CON SISTEMA DE CIERRE AMORTIGUADO. / SOFT CLOSING SYSTEM, BRAKE SYSTEM FOR THE DOOR CLOSURE IS AMORTIZED. / FERMETURE DES PORTES SOFT CLOSING, AVEC SYSTÈME DE FREIN POUR LA PORTE DE FERMETURE QUI EST AMORTIE.

CERRADURA CON FALLEBA PLANA LINEAL QUE EVITA LA VIBRACIÓN DE LA PUERTA. DISEÑO NOVEDOSO. / LINEAR FLAT DOOR BAR THAT PREVENTS VIBRATION OF DOOR. NEW DESIGN. / CRÉMONE LINÉAIRE PLAT QUI ÉVITE LA VIBRATION DE LA PORTE. CONCEPTION ORIGINALE.

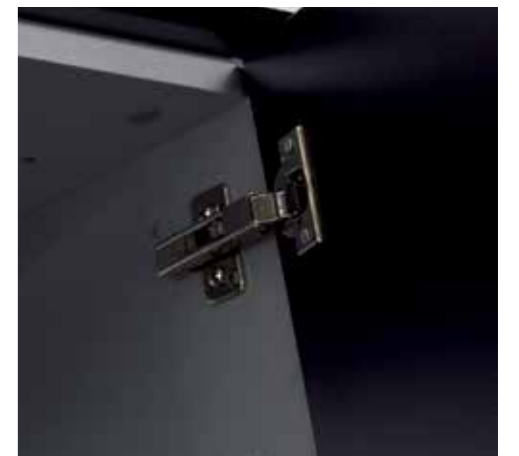

MONTAJE MESA /DESK ASSEMBLY / ASSEMBLAGE DU BUREAU.

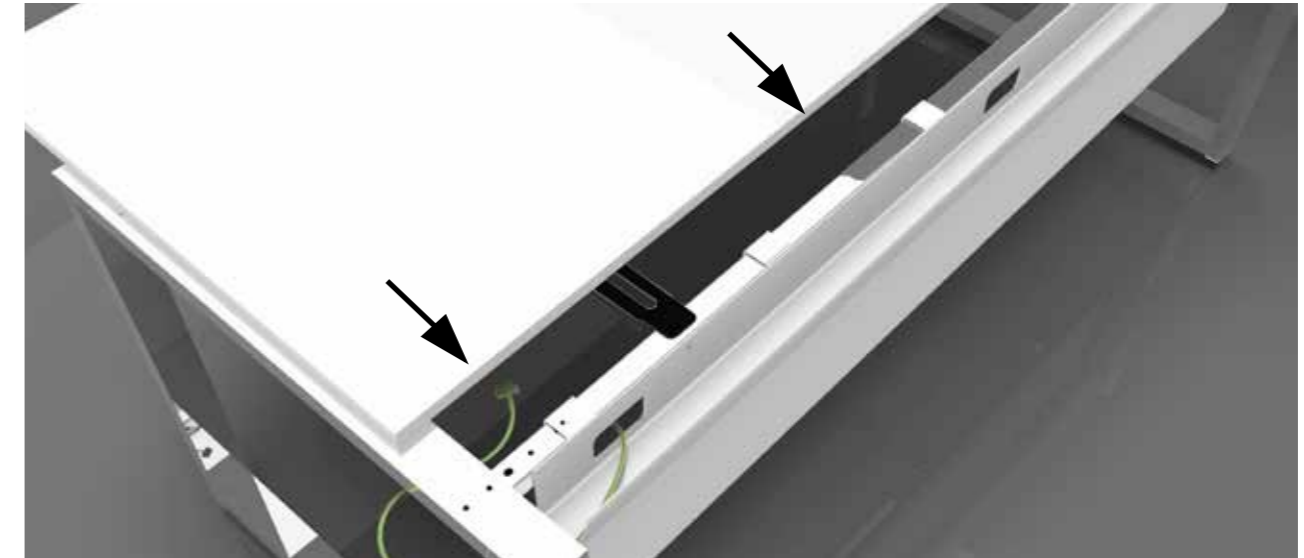

ACABADOS / FINISHES / FINITIONS.



ESTRUCTURA
STRUCTURE
STRUCTURE

BLANC
WHITE
BLANC



ESTRUCTURA
STRUCTURAL
STRUCTURE

CROM
CHROME
CHROME

MESA RECTANGULAR.
RECTANGULAR DESK.
BUREAUX RECTANGULAIRE.

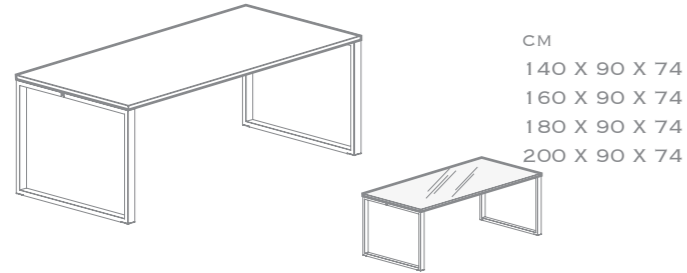

CM
140 X 90 X 74
160 X 90 X 74
180 X 90 X 74
200 X 90 X 74

FORRO LATERAL PARA ESTRUCTURA.
DECORATIVE PANEL FOR STRUCTURE.
LATÉRAL DÉCORATIF POUR STRUCTURE.

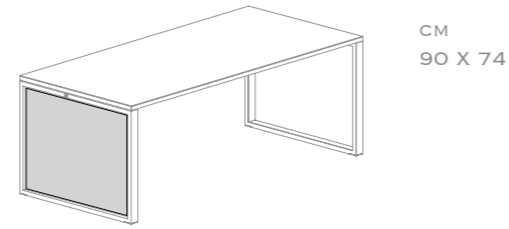

CM
90 X 74

ALA PARA MESA.
RETURN DESK.
RETOUR ACCROCHÉS.

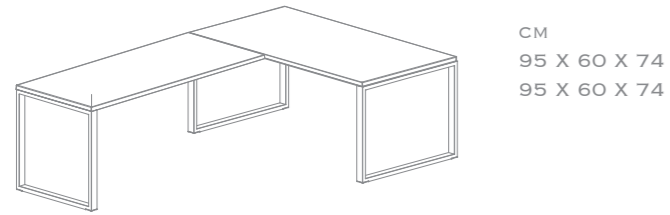

CM
95 X 60 X 74
95 X 60 X 74

MESA RECTANGULAR PARA CREDENZA.
DESK FOR CREDENZA.
BUREAUX POUR CRÉDENCE.

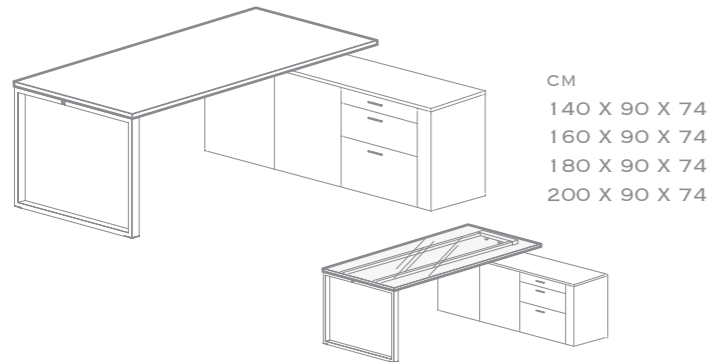

CM
140 X 90 X 74
160 X 90 X 74
180 X 90 X 74
200 X 90 X 74

MESA DE JUNTAS RECTANGULAR.
RECTANGULAR MEETING TABLE.
TABLE DE RÉUNION RECTANGULAIRE.

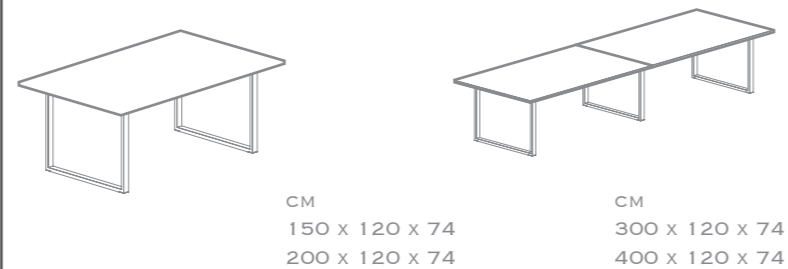

CM
150 x 120 x 74
200 x 120 x 74

CM
300 x 120 x 74
400 x 120 x 74

MESA DE JUNTAS CIRCULAR CON PATA CÁLIZ.
CIRCULAR MEETING TABLE WITH METALLIC LEG.
TABLE DE RÉUNION CIRCULAIRE PIED EN FONTE.

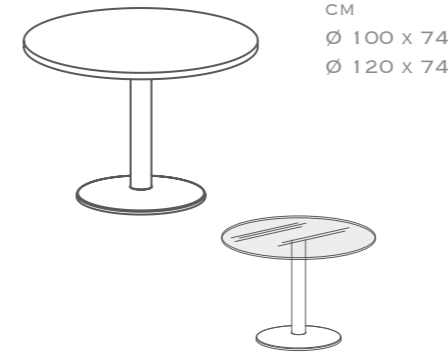

CM
Ø 100 x 74
Ø 120 x 74

FALDONES.
MODESTY PANELS.
VOILES DE FOND.

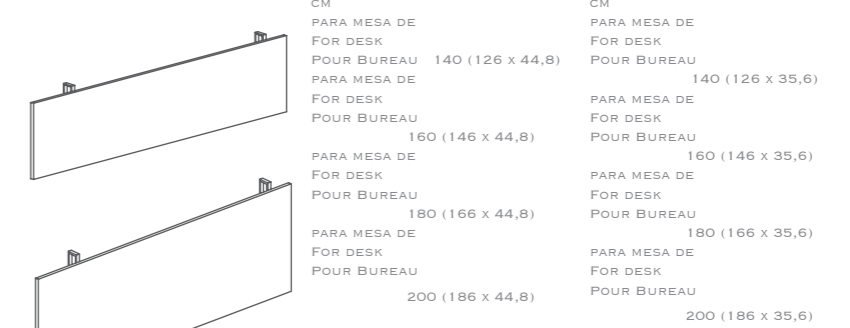

CM
PARA MESA DE
FOR DESK
POUR BUREAU 140 (126 x 44,8)
PARA MESA DE
FOR DESK
POUR BUREAU 160 (146 x 44,8)
PARA MESA DE
FOR DESK
POUR BUREAU 180 (166 x 44,8)
PARA MESA DE
FOR DESK
POUR BUREAU 200 (186 x 44,8)

CM
PARA MESA DE
FOR DESK
POUR BUREAU 140 (126 x 35,6)
PARA MESA DE
FOR DESK
POUR BUREAU 160 (146 x 35,6)
PARA MESA DE
FOR DESK
POUR BUREAU 180 (166 x 35,6)
PARA MESA DE
FOR DESK
POUR BUREAU 200 (186 x 35,6)

BANDEJA PASACABLES HORIZONTAL.
HORIZONTAL CABLE TRAY.
GOULOTTE HORIZONTALE.

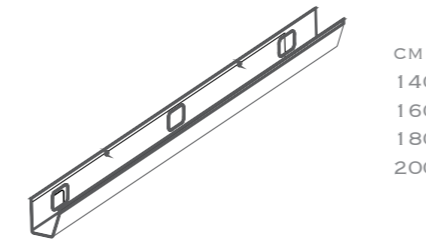

CM
140
160
180
200

PASACABLES VERTICAL.
VERTICAL CABLE HOLDER.
PASSE CABLES VERTICAL.



CM
L8,0 x W55,8 x H3,0

PASACABLES VERTICAL TUBULAR.
VERTICAL CABLE COLLECTOR.
ACCESSOIRE VERTICAL POUR DESCENTE
DE CABLES.



CM
Ø 60

PASACABLES CON CEPILLO.
COVER WITH BRUSH GUARD.
PASSE CABLES AVEC BROSSE.



CM
L32 x W11 x H1,3

POWER BOX.
POWER BOX.
POWER BOX.

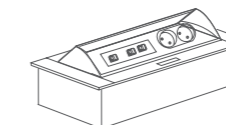

CM
L26,6 x W13,5 x H6,8

POWER BOX.
POWER BOX.
POWER BOX.

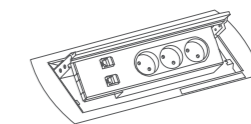

CM
L35,86 x W17 x H7,5

CREDENZA COMO SOPORTE MESA.
 CREDENZA SUPPORTING DESK.
 CRÉDENCE COMME MEUBLE PORTEUR.

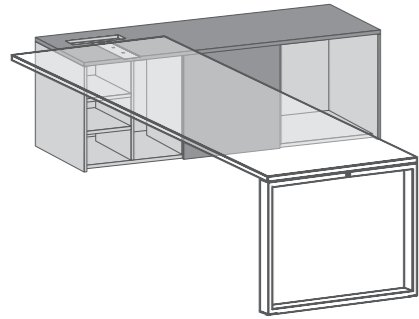

CM
 175 x 61 x 64

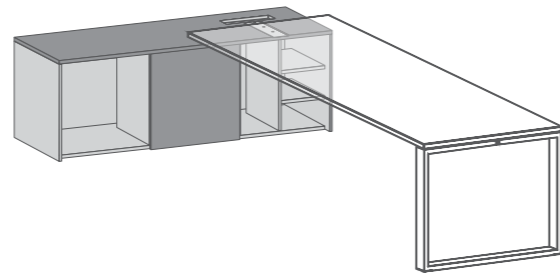

CM
 175 x 61 x 64

CAJONERA + ESTANTE PARA MÓDULO 1 DE LA CREDENZA.
 DRAWER UNIT + SHELF FOR MODULE 1 OF THE RETURN CREDENZA.
 CAISSON + ÉTAGÈRE POUR MODULE 1 DE LA CRÉDENCE.

CAJONERA + TAPETA PARA MÓDULO 1 DE LA CREDENZA.
 DRAWER UNIT + COVER FOR MODULE 1 OF THE RETURN CREDENZA.
 CAISSON + CACHE POUR MODULE 1 DE LA CRÉDENCE.

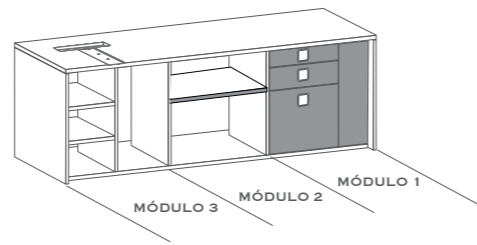
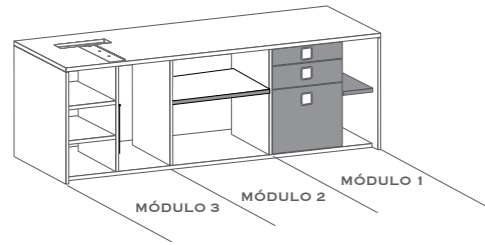

CAJONERA + POWER BOX PARA MÓDULO 1 DE LA CREDENZA.
 DRAWER UNIT + POWER BOX FOR MODULE 1 OF THE RETURN CREDENZA.
 CAISSON + POWER BOX POUR MODULE 1 DE LA CRÉDENCE.

CAJONERA + POWER BOX PARA MÓDULO 1 DE LA CREDENZA MUEBLE ALA.
 SHELF FOR MODULE 1 OF THE RETURN CREDENZA.
 ÉTAGÈRE POUR MODULE 1 DE LA CRÉDENCE RETOUR.

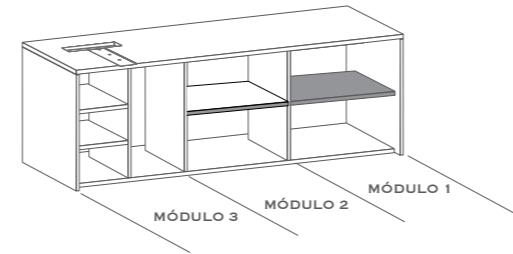
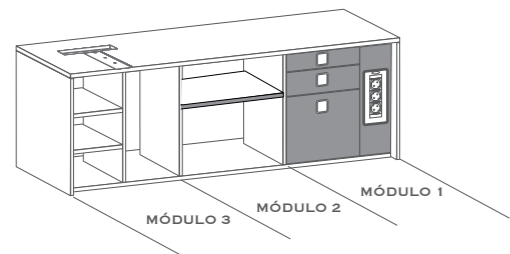

PUERTA ADICIONAL PARA MÓDULO 3.
 ADDITIONAL DOOR FOR MODULE 3.
 PORTE ADDITIONNELLE POUR MODULE 3.

PASACABLES ADICIONAL Ø8 CM.
 Ø8 CM CABLE GROMMET.
 OBTURATEUR Ø8 CM.

TIRADORES ADICIONALES.
 ADDITIONAL HANDLES.
 POIGNÉES ADDITIONNELLES.

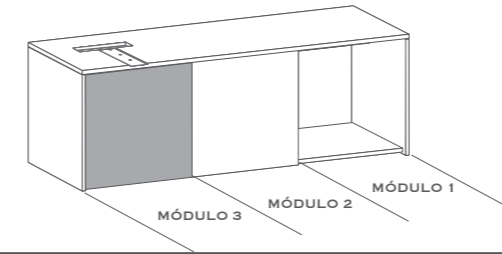

CM
 Ø8



CM
 L20 x H2,0



CM
 L15 x H2,0

BLANCO / ALUMINIO / CROMADO.

CREDENZA.
 CREDENZA.
 CRÉDENCE.

ESTANTE PARA MÓDULO 2 DE LA CREDENZA.
 SHELF FOR MODULE 2 OF THE CREDENZA.
 ÉTAGÈRE POUR MODULE 2 DE LA CRÉDENCE.

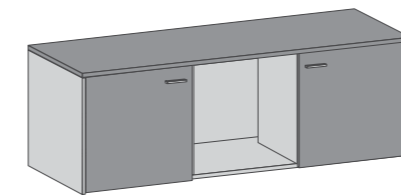

CM
 175 x 61 x 64

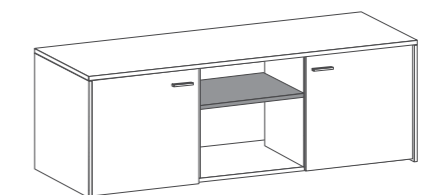

CAJONERA 4C PARA MÓDULO 2 DE LA CREDENZA.
 4 DRAWER UNIT FOR MODULE 2 OF THE CREDENZA.
 CAISSON 4T POUR MODULE 2 DE LA CRÉDENCE.

KIT 8 RUEDAS.
 KIT OF 8 CASTORS.
 KIT 8 ROULETTES.

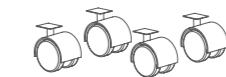
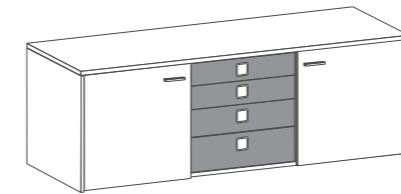

CM
 H=10

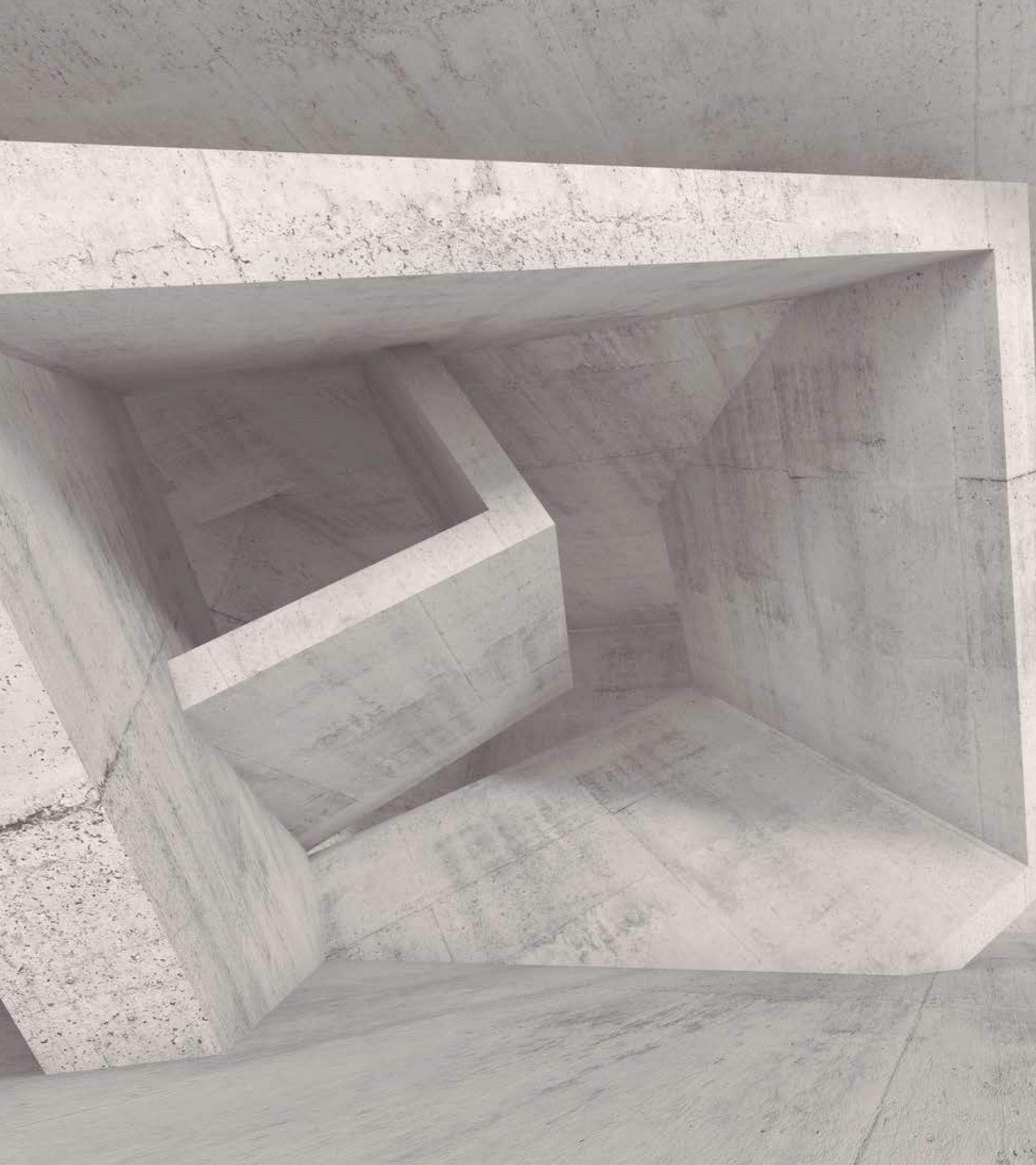

I.POP/O.POP

OPERATIVA

SERIE OPERATIVA CON ESTILO VIBRANTE, CON UN PODEROSO SENTIDO DE IDENTIDAD PROPIO. GAMA COMPLETA, LLENA DE POSIBILIDADES QUE SATISFACE CUALQUIER NECESIDAD QUE PUEDA SURGIR.

OPERATIONAL RANGE WITH VIBRANT STYLE AND WITH A POWERFUL SENSE OF OWN IDENTITY. COMPLETE RANGE, FULL OF POSSIBILITIES THAT SATISFIES ANY NEED THAT MAY ARISE.

GAMME OPÉRATIONNELLE AVEC UN STYLE DYNAMIQUE ET AVEC UN SENS PUISSANT DE SA PROPRE IDENTITÉ. GAMME COMPLÈTE, PLUSIEURS POSSIBILITÉS QUI RÉPONDENT À TOUS LES BESOINS.



DESIGN: (BILAMINADO) ROBLE , OAK, CHÈNE CLAIRE (LUXE) BLANCO,
WHITE, BLANC.





DESIGN: (LUXE MATT) BASALTO SM.



DESIGN: (LUXE) CACHEMIR.

SOPORTE CPU METÁLICO SUSPENDIDO DE UN RAÍL QUE SE INSTALA A LO ANCHO DE LA MESA Y QUE PERMITE COLOCARLO EN LA POSICIÓN MÁS IDÓNEA PARA EL USUARIO, PUDIENDO CAMBIAR DICHA POSICIÓN CUANTAS VECES SEA NECESARIO A TRAVÉS DEL SISTEMA DE ACCIONAMIENTO MANUAL, QUE SE DESENROSCA PARA SU MOVIMIENTO Y SE ENROSCA PARA SU AJUSTE UNA VEZ ELEGIDA LA POSICIÓN.

METALLIC CPU SUPPORT SUSPENDED FROM A RAIL WHICH IS INSTALLED ALONG THE WIDTH OF THE DESK, ALLOWING TO PLACE THE CPU IN THE POSITION MOST SUITABLE FOR THE END USER, WHO MAY CHANGE THAT POSITION MANY TIMES AS NECESSARY, THROUGH THE MANUAL SYSTEM, THAT UNSCREWS FOR MOVEMENT AND THREADED FOR ADJUST TO THE CHOSEN POSITION.

SUPPORT CPU MÉTALLIQUE SUSPENDU D'UN RAIL QUI EST INSTALLÉ LE LONG DE LA LARGEUR DU BUREAU, PERMETTANT DE PLACER L'UNITÉ CENTRALE DANS LA POSITION LE PLUS APPROPRIÉ POUR L'UTILISATEUR FINAL, QUI PEUT MODIFIER CETTE POSITION À PLUSIEURS REPRISSES QUE NÉCESSAIRE, PAR L'INTERMÉDIAIRE DU SYSTÈME COMMANDE MANUELLE, QUI DÉVISSE POUR LE MOUVEMENT ET FILETÉ POUR AJUSTER LA POSITION UNE FOIS CHOISI.

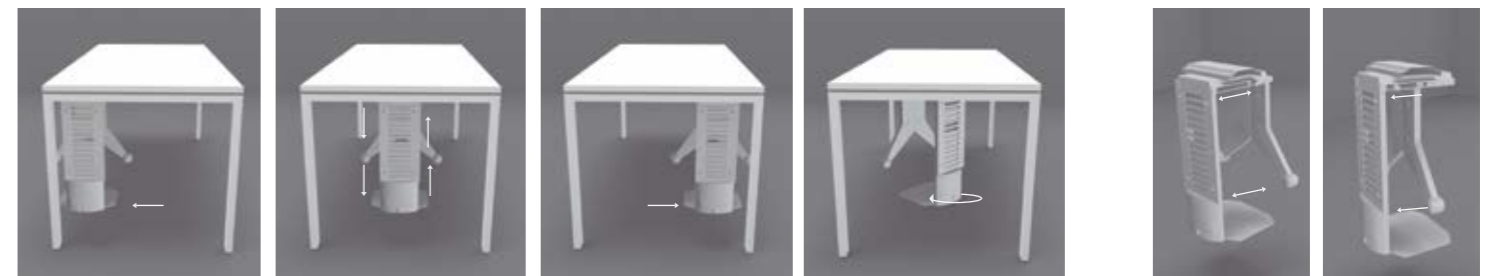

INTEGRA UN SOFISTICADO SISTEMA DE ELECTRIFICACIÓN QUE FACILITA LA INSTALACIÓN Y LA CANALIZACIÓN DEL CABLEADO.

SOPHISTICATED WIRING MANAGEMENT SYSTEM. MAXIMUM ACCESSIBILITY TO THE WIRING AND CONNECTIONS.

SOPHISTIQUE SYSTÈME D'ÉLECTRIFICATION QUI PERMET UNE ACCESSIBILITÉ MAXIMALE AU CÂBLAGE ET AUX CONNEXIONS.





DESIGN: (BILAMINADO) ROBLE , OAK, CHÈNE CLAIRE (LUXE) BLANCO, WHITE, BLANC.

UNA SOLUCIÓN ELEGANTE, QUE SINTETIZA, REDUCE E INTEGRA LOS ELEMENTOS. LA ELECTRIFICACIÓN A TRAVÉS DEL ARMARIO FACILITA EL CABLEADO DE TODO EL PUESTO DE TRABAJO EN CONJUNTO.

AN ELEGANT SOLUTION, WHICH SYNTHESIZES, REDUCES AND INTEGRATES THE ELEMENTS. ELECTRIFICATION THROUGH THE WARDROBE MAKES WIRING OF ALL THE WORKSTATION TOGETHER.

UNE SOLUTION ÉLÉGANTE, QUI SYNTHÉTISE, RÉDUITE ET INTÈGRE LES ÉLÉMENTS. L'ÉLECTRIFICATION DANS L'ARMOIRE REND LE CÂBLAGE SUR TOUT L'ENSEMBLE DU POSTE DE TRAVAIL.



DESIGN: (BILAMINADO) ROBLE , OAK, CHÈNE CLAIRE

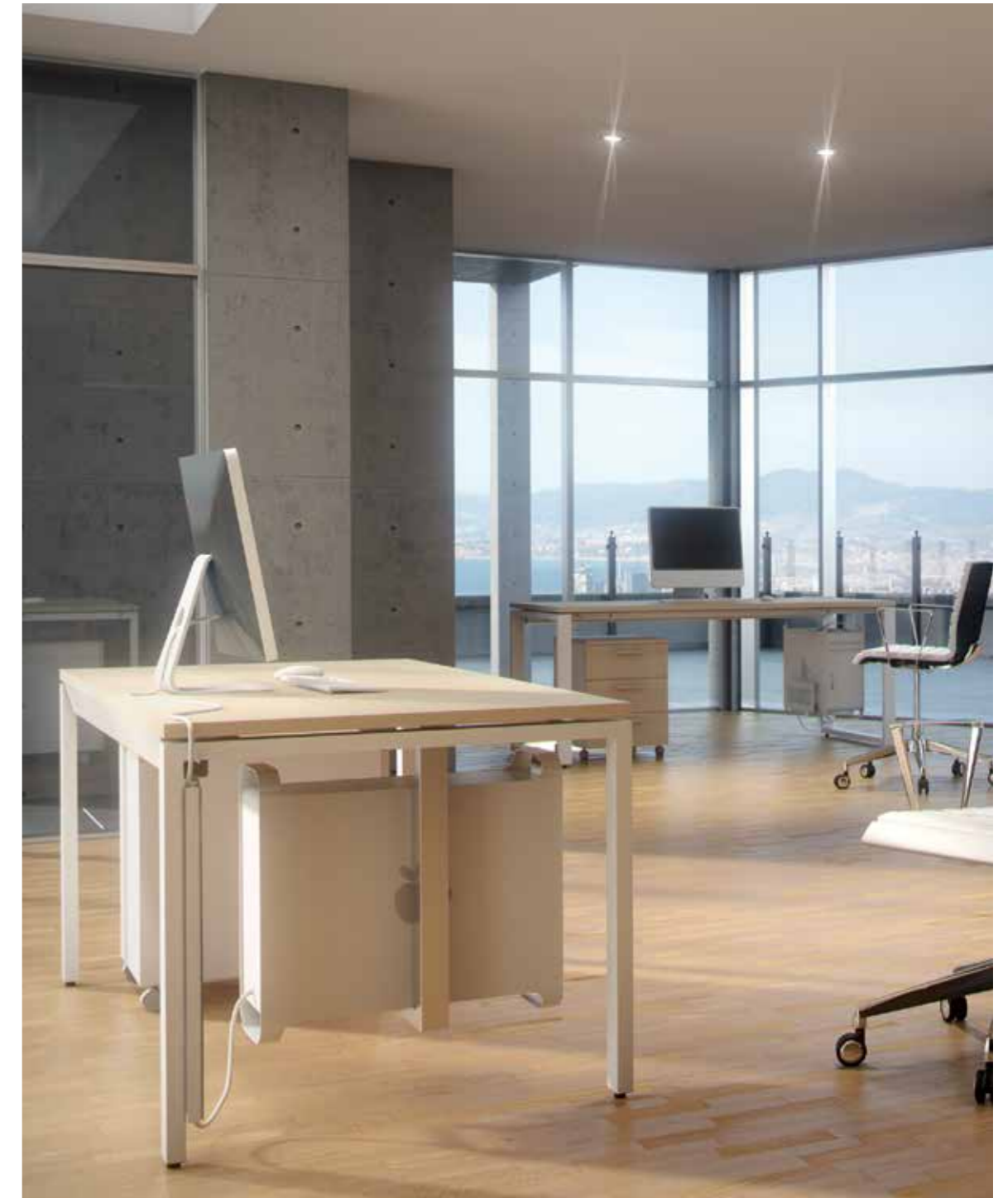

DESIGN: (BILAMINADO) ARCE , MAPLE, ERABLE.





DESIGN: (BILAMINADO) BLANCO, WHITE, BLANC.





DESIGN: (BILAMINADO) NEBRASKA. BLANCO, WHITE, BLANC.

FÁCIL SISTEMA DE MONTAJE. SISTEMA DE MONTAJE SENCILLO Y RÁPIDO MEDIANTE EL USO MÍNIMO DE TORNILLERÍA. / EASY ASSEMBLY SYSTEM. SYSTEM FOR QUICK AND EASY INSTALLATION WITH MINIMAL USE OF SCREWS. / SYSTÈME DE MONTAGE FACILE. SYSTÈME POUR UNE INSTALLATION RAPIDE ET FACILE AVEC UNE UTILISATION MINIMALE DE VIS.



COMBINACIÓN ELEGANTE Y PRÁCTICA. MAYOR ORGANIZACIÓN EN LOS ESPACIOS DE TRABAJO. / STYLISH AND PRACTICAL COMBINATION. GREAT PERFORMANCE IN THE OFFICE. / COMBINAISON ÉLÉGANTE ET PRATIQUE. PLUS GRANDE ORGANISATION DES ESPACES DE TRAVAIL.

I.POP PERMITE CONECTAR TODA LA ESTRUCTURA A LA TOMA DE TIERRA A TRAVÉS DE UN PUNTO DE CONEXIÓN UBICADO EN LA MISMA ESTRUCTURA. I.POP ALLOWS TO CONNECT THE STRUCTURE TO GROUND THROUGH A CONNECTION POINT LOCATED ON THE SAME STRUCTURE. I.POP PERMET BRANCHER TOUTE LA STRUCTURE À LA PRISE DE TERRE À TRAVERS D'UN POINT DE CONNEXION SITUÉ SUR LA MÊME STRUCTURE.



DESIGN: (BILAMINADO) ROBLE , OAK, CHÈNE CLAIRE.



DESIGN: (LUXE) BLANCO, WHITE, BLANC. (LUXE) BURDEOS, BURGUNDY, BORDEAUX.



DESIGN: (LUXE) BLANCO, WHITE, BLANC.

ACCESIBILIDAD TOTAL AL CANAL DE ELECTRIFICACIÓN. EL DESPLAZAMIENTO DE TABLEROS DE MESA DOBLES E INDIVIDUALES HACIA EL USUARIO PERMITE UN FÁCIL ACCESO AL CANAL DE ELECTRIFICACIÓN.

COMPLETE ACCESS TO THE CABLE TRAY. SLIDING DESKTOPS ON BENCH AND SINGLE DESKS ALLOW AN EASY ACCESS TO THE CABLE TRAY.

ACCÈS COMPLET À LA GOULOTTE L'ÉLECTRIFICATION. LE DÉPLACEMENT DE PLATEAUX DES PLANS DOUBLES ET INDIVIDUELS VERS L'UTILISATEUR PERMET UN ACCÈS FACILE À LA GOULOTTE D'ÉLECTRIFICATION.



DESIGN: (LUXE) BLANCO, WHITE, BLANC. (LUXE) BURDEOS, BURGUNDY, BORDEAUX.(LUXE MATT) ANTRACITA METALDECO SM.



MESAS INDIVIDUALES Y DE PROGRESIÓN QUE PERMITEN REALIZAR MÚLTIPLES CONFIGURACIONES EN LAS QUE ES NECESARIO ACOMODAR A GRAN CANTIDAD DE PERSONAS: UNIVERSIDADES, ZONAS DE FORMACIÓN, AULAS EDUCATIVAS O DE CONVENCION.

INDIVIDUAL DESKS AND EXTENSIONS, THAT ALLOW MULTIPLE CONFIGURATIONS, WHICH IS NECESSARY TO ACCOMMODATE A LOT OF PEOPLE: UNIVERSITIES, TRAINING AREAS, CLASSROOMS OR CONVENTION HALLS.

BUREAUX INDIVIDUELS ET DE PROLONGATION QUI PERMETTENT DE MULTIPLES CONFIGURATIONS, CE QUI EST NÉCESSAIRE POUR ACCUEILLIR UN GRAND NOMBRE DE PERSONNES: LES UNIVERSITÉS, LES SALLES DE FORMATION, SALLES DE CLASSE OU DE CONGRÈS.





DESIGN: (LUXE MATT) BASALTO SM.

ACABADOS EXCLUSIVOS, DISPONIBLES EN TODOS NUESTROS PRODUCTOS.

EXCLUSIVE FINISHES, AVAILABLE IN ALL OUR PRODUCTS

FINITIONS EXCLUSIVES, DISPONIBLES DANS TOUTES NOS GAMMES



DESIGN: (LUXE MATT) ANTRACITA METALDECO SM. (LUXE) BLANCO, WHITE, BLANC.

DESIGN: (LUXE MATT) ANTRACITA METALDECO SM. (LUXE) BLANCO, WHITE, BLANC.



DESIGN: (LUXE) BLANCO, WHITE, BLANC. (LUXE) BURDEOS, BURGUNDY, BORDEAUX.



DESIGN: (LUXE MATT) ANTRACITA METALDECO SM.







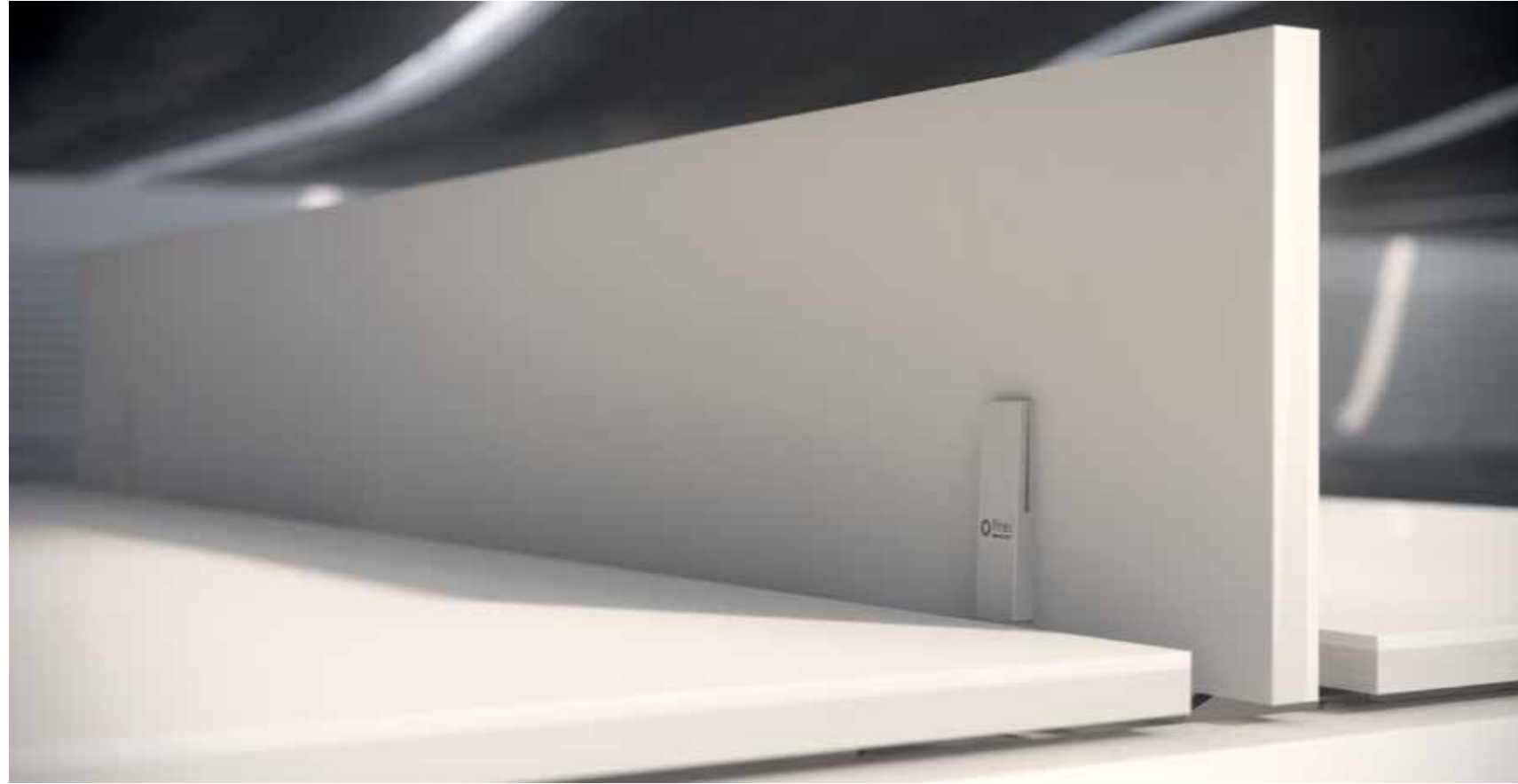

TABLERO DESPLAZABLE PARA ACCESO A CANAL DE ELECTRIFICACIÓN. / SLIDING DESKTOP TO ACCESS CABLE TRAY. / PLATEAU COULISSANT POUR ACCÈS À GOULOTTE D'ÉLECTRIFICATION.

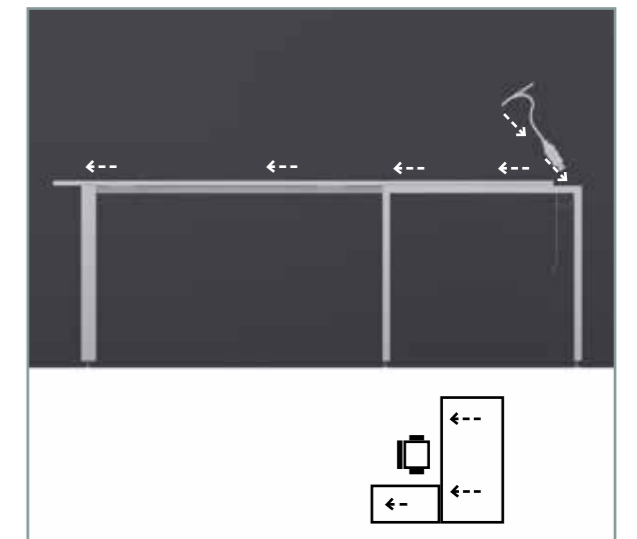
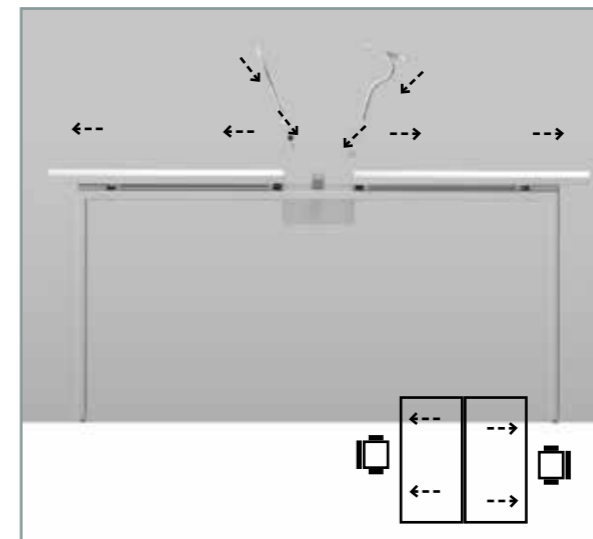

ELEVATOR

UNA PRÁCTICA COMBINACIÓN DE DISEÑO SOFISTICADO Y MECÁNICA DE PRECISIÓN CUANDO NO SE UTILIZA QUEDA OCULTA ENCIMA DE LA MESA. PARA ELEVARLA, SIMPLEMENTE TÓQUELA. / L'ALLIANCE PRATIQUE D'UN DESIGN RECHERCHÉ ET D'UNE CONSTRUCTION MÉCANIQUE PRÉCISE. LORSQU'ELLE N'EST PAS UTILISÉE, L'UNITÉ AFFLEURE LE DESSUS DU BUREAU OU DE LA TABLE. UNE SIMPLE PRESSION SUFFIT À LA DÉPLOYER.



TWIST

COMPACTO Y EXCELENTE SISTEMA DE GESTIÓN PARA EL AHORRO DE ESPACIO PARA LOS CABLES. TWIST ES SUFICIENTEMENTE PLANO PARA NO INTERFERIR CON UNIDADES QUE SE ENCUENTREN EN LA PARTE INFERIOR. PREMIO RED DOT DESIGN 2012. / TRÈS COMPACT ET PEU ENCOMBRANT. TWIST EST SI PLAT QU'IL IL LIBÈRE L'ESPACE SOUS VOTRE PLAN DE TRAVAIL. RÉCOMPENSÉ PAR LE PRIX RED DOT DESIGN 2012.



POWER FRAME

CUBIERTA ELEGANTE Y ATRACTIVA QUE ES PARTICULARMENTE ADECUADA PARA OFICINAS MODERNAS O SALAS DE CONFERENCIAS. / FOR INTEGRATED POWER AND DATA CONNECTIONS TO WORKSTATIONS. VERSATILE APPLICATION OPTIONS. THE POWER STRIP SIMPLY CLICKS INTO THE BUILT-IN FRAME. AVEC SON COUVERCLE ENTièrement RABATTABLE, CHAQUE INTERLOCUTEUR BÉNÉFICIE DE SON SIÈGE, D'UN ACCÈS DIRECT À L'ALIMENTATION ÉLECTRIQUE ET AUX DONNÉES. UN ÉLÉGANT ET MAGNIFIQUE COUVERCLE EN ALUMINIUM DÉDIE CE PRODUIT AUX SALLES DE CONFÉRENCE, MAIS AUSSI, OÙ L'ON RECHERCHE UNE CERTAINE AMBIANCE AU BUREAU.



MESA RECTANGULAR (19 / 25).
RECTANGULAR DESK (19 / 25).
BUREAUX RECTANGULAIRE (19 / 25).

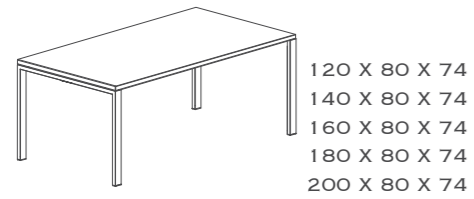

120 X 80 X 74
140 X 80 X 74
160 X 80 X 74
180 X 80 X 74
200 X 80 X 74

MESA RECTANGULAR (CRISTAL).
RECTANGULAR DESK (GLASS).
BUREAUX RECTANGULAIRE (VERRE).

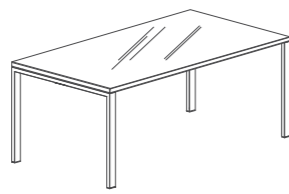

160 X 80 X 74
180 X 80 X 74
200 X 80 X 74

EXTENSIÓN MESA (19 / 25).
DESK EXTENTIONS(19 / 25).
PROLONGATIONS DE BUREAUX(19 / 25).

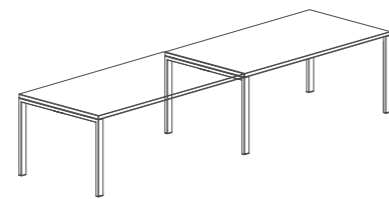

120 X 80 X 74
140 X 80 X 74
160 X 80 X 74
180 X 80 X 74
200 X 80 X 74

ALA(19 / 25).
RETURN DESKS(19 / 25).
RETOUR ACCROCHÉS(19 / 25).

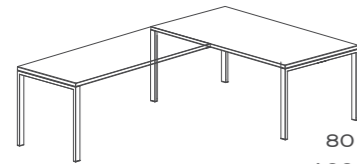

80 X 60 X 74
100 X 60 X 74
120 X 60 X 74

ALA CRISTAL.
RETURN DESKS GLASS.
RETOUR ACCROCHÉS VERRE.

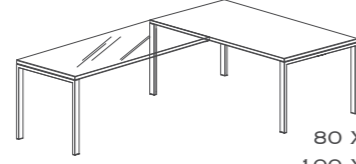

80 X 60 X 74
100 X 60 X 74

MESA AUXILIAR RECTA(19 / 25).
AUXILLIARY DESKS(19 / 25).
RETOURS AUXILIAIRES(19 / 25).

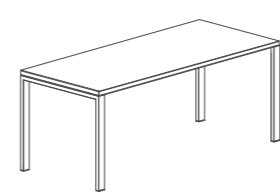

120 X 60 X 74
140 X 60 X 74
160 X 60 X 74
180 X 60 X 74
200 X 60 X 74

EXTENSIÓN MESA(19 / 25).
DESKS EXTENSIONS(19 / 25).
PROLONGATIONS DE RETOURS AUXILIAIRES(19 / 25).

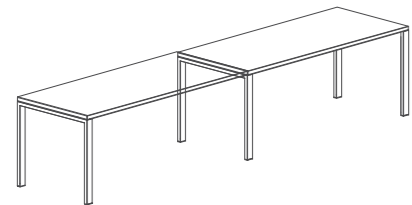

120 X 60 X 74
140 X 60 X 74
160 X 60 X 74
180 X 60 X 74
200 X 60 X 74

MUEBLE ALA (19 / 25).
DESKS WITH CREDENZA(19 / 25).
BUREAUX POUR CRÉDENCE(19 / 25).

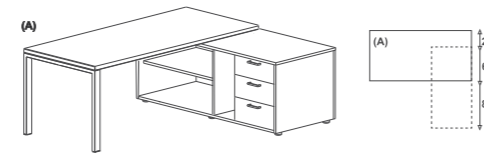

(A)
20
60
80

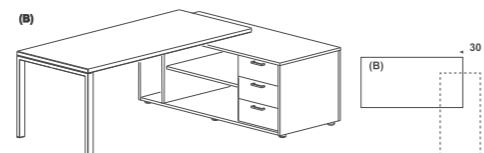

(B)
30
20
60
80

160 X 80 X 74
180 X 80 X 74
200 X 80 X 74

MESA DOBLE PARA MUEBLE ALA (19).
BENCH DESKS FOR CREDENZA (19).
PLANS DOUBLES POUR CRÉDENCE (19).

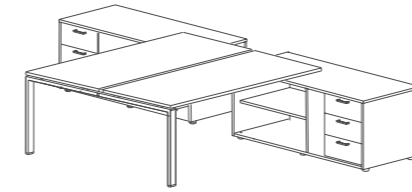

(A)
80
60
20
20
80

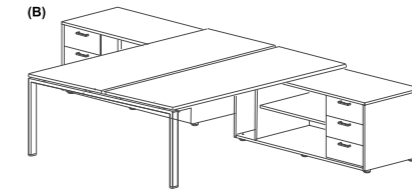

(B)
80
60
20
20
80

160 X 164 X 74
180 X 164 X 74
200 X 164 X 74

MESA DOBLE (19).
BENCH DESKS (19).
PLANS DOUBLES (19).



120 X 164 X 74
140 X 164 X 74
160 X 164 X 74
180 X 164 X 74
200 X 164 X 74

EXTENSIÓN PARA MESA DOBLE (19).
BENCH DESK EXTENSIONS WITH RETRACTED LEG (19).
PROLONGATIONS DOUBLES AVEC PIED RENTRÉ (19).

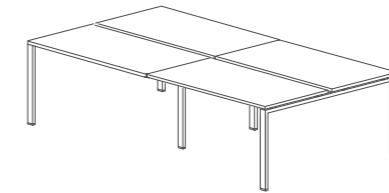

120 X 164 X 74
140 X 164 X 74
160 X 164 X 74
180 X 164 X 74
200 X 164 X 74

ALA PARA MESA DOBLE (19).
RETURN DESK FOR BENCH DESKS (19).
RETOUR ACCROCHÉS POUR PLANS DOUBLES (19)..

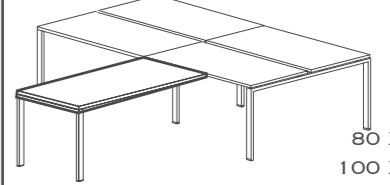

80 X 60 X 74
100 X 60 X 74
120 X 60 X 74

MINI BENCH (19).
MINI BENCH DESKS (19).
PLANS MINI BENCH (19).

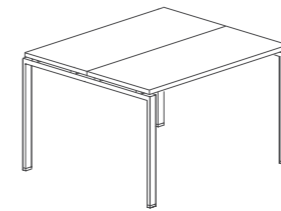

120 X 120 X 74
140 X 120 X 74
160 X 120 X 74
180 X 120 X 74
200 X 120 X 74

EXTENSIÓN PARA MINI BENCH (19).
MINI BENCH EXTENSIONS (19).
PROLONGATIONS MINI BENCH (19).

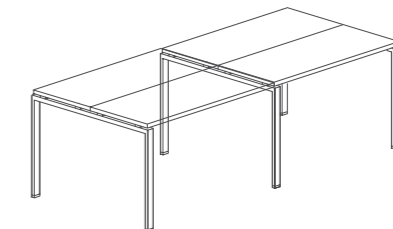

120 X 120 X 74
140 X 120 X 74
160 X 120 X 74
180 X 120 X 74
200 X 120 X 74

MESA DE 90° PARA COMPOSER (25).
90°BENCH DESKS TO COMPOSE (25).
PLANS DOUBLES 90°À COMPOSER (25).

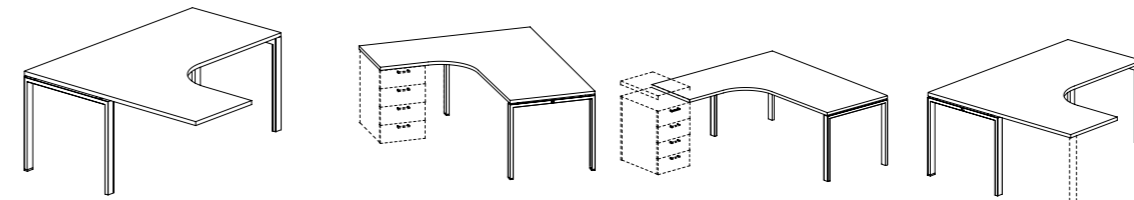

140 X 120 X 60 x 75 (D / I)
160 X 120 X 60 x 75 (D / I)
160 X 140 X 60 x 75 (D / I)
160 X 160 X 60 x 75 (D / I)
180 X 120 X 60 x 75 (D / I)
180 X 140 X 60 x 75 (D / I)
180 X 160 X 60 x 75 (D / I)

TAPETA EMBELLECEDORA ELEVADA.
FINISHING COUVER.
CACHE-OBTURATEUR.

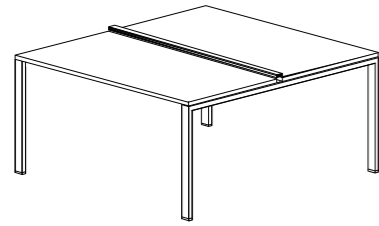

L120
L140
L160
L180
L200

TAPETA EMBELLECEDORA ENRASADA.
FINISHING COUVER.
CACHE-OBTURATEUR.

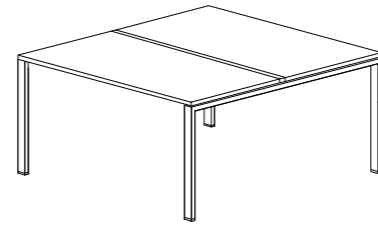

L120
L140
L160
L180
L200

FALDÓN LAMINADO.
LAMINATED MODESTY PANELS.
VOILES DE FOND MELAMINÉS.

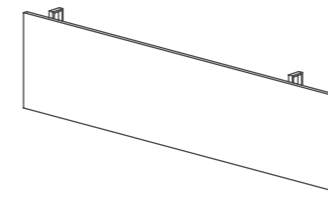

L1200 (868x29.5)
L1400 (1068x29.5)
L1600 (1268x29.5)
L1800 (1468x29.5)

FALDÓN METÁLICO.
METAL MODESTY PANEL.
VOILES DE FOND MÉTALLIQUES.

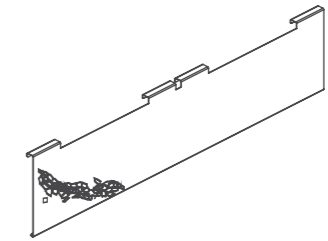

L1200 (868x29.5)
L1400 (1068x29.5)
L1600 (1268x29.5)
L1800 (1468x29.5)

PANTALLAS MESA BENCH.
SCREENS FOR BENCH OR MINI BENCH DESKS.
ÉCRANS POUR PLANS DOUBLES OU MINI BENCH.

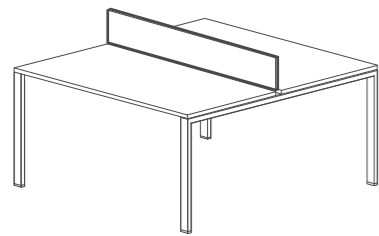

L120
L140
L160
L180
L200

PANTALLAS METACRILATO PARA MESA BENCH.
METHACRYLATE SCREEN FOR BENCH DESKS.
ÉCRANS EN MÉTHACRYLATE TRANSLUCIDE
POUR PLANS DOUBLES.

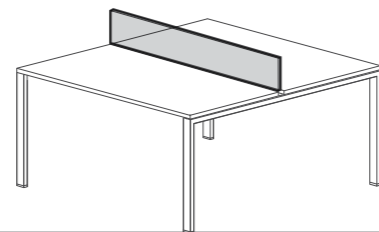

L120
L140
L160
L180
L200

PANTALLAS CON MARCO DE ALUMINIO PARA MESAS BENCH.
SCREENS WITH ALUMINIUM FRAME FOR BENCH DESKS.
ÉCRANS AVEC CADRE EN ALUMINIUM POUR PLANS DOUBLES.

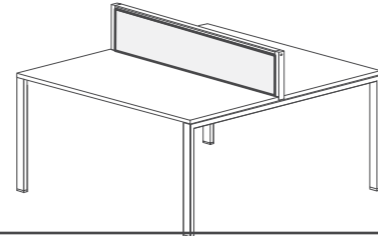

L120
L140
L160
L180
L200

PASA CABLES VERTICAL.
VERTICAL CABLE HOLDER.
ACCESOIRES VERTICAL POUR DESCENTE DE CABLES.



BANDEJA PASA CABLES HORIZONTAL MESA DOBLE.
HORIZONTAL CABLE TRAY.
GOULOTTE HORIZONTALE.

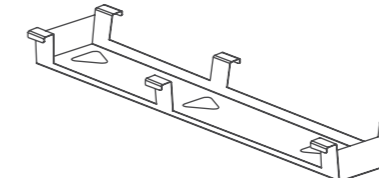

L1200
L1400
L1600
L1800

BANDEJA PASA CABLES HORIZONTAL MESA INDIVIDUAL.
HORIZONTAL CABLE TRAY FOR BENCH DESK.
GOULOTTE HORIZONTALE POUR PLANS DOUBLES

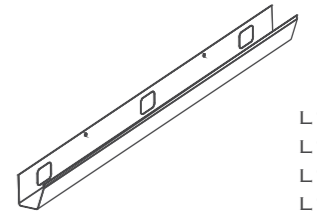

L1200
L1400
L1600
L1800

PANTALLA LATERAL.
SIDE SCREENS FOR INDIVIDUAL DESK.
ÉCRANS LATÉRAUX.

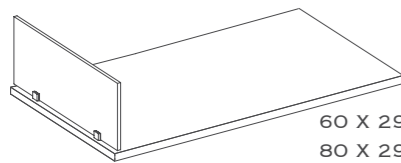

60 X 29 X 1,9
80 X 29 X 1,9

PANTALLA LATERAL METACRILATO.
METHACRYLATE SIDE SCREEN.
ÉCRANS LATÉRAUX EN MÉTHACRYLATE.

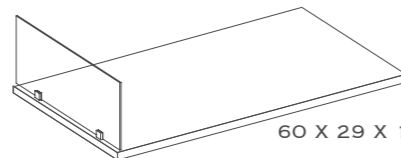

60 X 29 X 1,9

PANTALLA FRONTAL.
FRONTAL SCREENS.
ÉCRANS FRONTAUX.

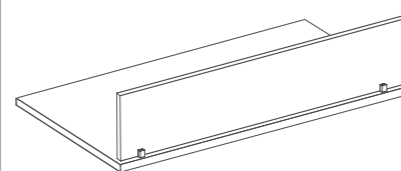

100 X 29 X 1,9
120 X 29 X 1,9
140 X 29 X 1,9
160 X 29 X 1,9
180 X 29 X 1,9
200 X 29 X 1,9

PANTALLA FRONTAL DE METACRILATO.
METHACRYLATE FRONTAL SCREENS.
ÉCRANS FRONTAUX EN MÉTHACRYLATE.

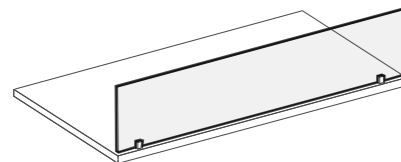

100 X 29 X 1,9
120 X 29 X 1,9
140 X 29 X 1,9
160 X 29 X 1,9

SOPORTES PARA PANTALLAS.
SHAPED BRACKETS.
SUPPORT POUR ÉCRANS.

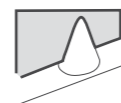

FOR LATERAL
SCREEN

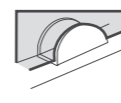

FOR
METHACRYLATE

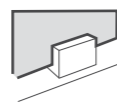

FOR FRONTAL
SCREEN

CPU.
CPU.
CPU.

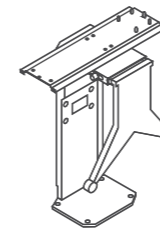

CPU.
CPU.
CPU.

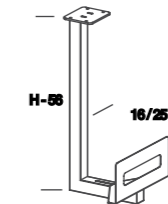

TOTEM.
TOTEM.
TOTEM.

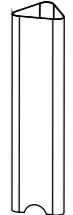

MESA RECTANGULAR (19 / 25).
RECTANGULAR DESK (19 / 25).
BUREAUX RECTANGULAIRE (19 / 25).

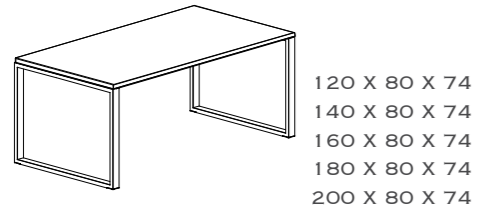

EXTENSIÓN MESA (19 / 25).
DESK EXTENTIONS(19 / 25).
PROLONGATIONS DE BUREAUX(19 / 25).

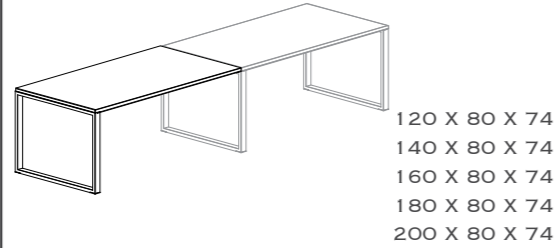

ALA(19 / 25).
RETURN DESKS(19 / 25).
RETOUR ACCROCHÉS(19 / 25).

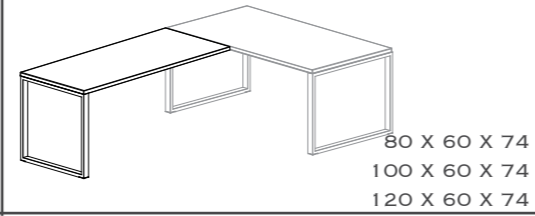

MESA RECTANGULAR (CRISTAL).
RECTANGULAR DESK (GLASS).
BUREAUX RECTANGULAIRE (VERRE).

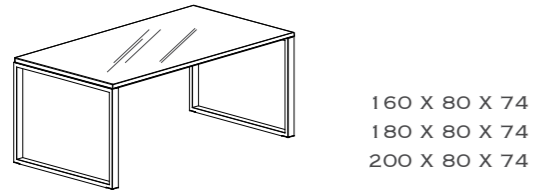

ALA CRISTAL .
RETURN DESKS GLASS.
RETOUR ACCROCHÉS VERRE.

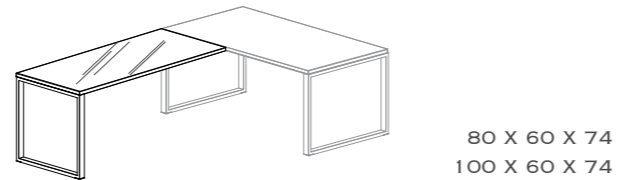

MESA AUXILIAR RECTA(19 / 25).
AUXILIARY DESKS(19 / 25).
RETOURS AUXILIAIRES(19 / 25).

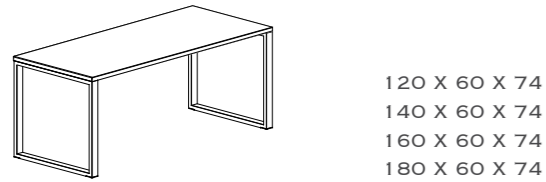

EXTENSIÓN MESA(19 / 25).
DESKS EXTENSIONS(19 / 25).
PROLONGATIONS DE RETOURS AUXILIAIRES(19 / 25).

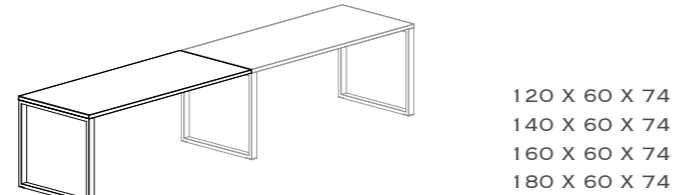

MUEBLE ALA (19 / 25).
DESKS WITH CREDENZA(19 / 25).
BUREAUX POUR CRÉDENCE(19 / 25).

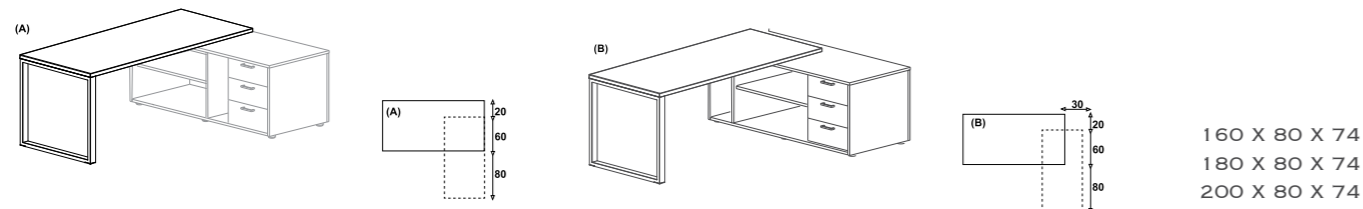

MESA DOBLE (19).
BENCH DESKS (19).
PLANS DOUBLES (19).

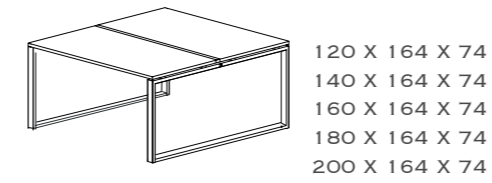

EXTENSIÓN PARA MESA DOBLE (19).
BENCH DESK EXTENSIONS WITH RETRACTED LEG (19).
PROLONGATIONS DOUBLES AVEC PIED RENTRÉ (19).

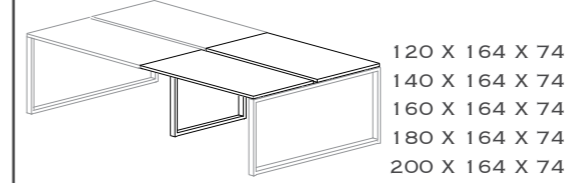

ALA PARA MESA DOBLE (19).
RETURN DESK FOR BENCH DESKS (19).
RETOUR ACCROCHÉS POUR PLANS DOUBLES (19)..

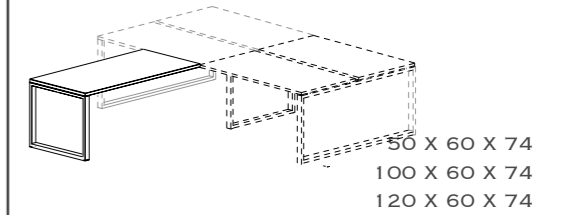

MESA RECTANGULAR (19 / 25).
RECTANGULAR DESK (19 / 25).
BUREAUX RECTANGULAIRE (19 / 25).

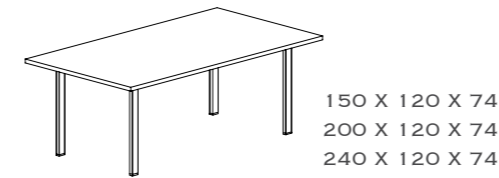

EXTENSIÓN MESA (19 / 25).
DESK EXTENTIONS(19 / 25).
PROLONGATIONS DE BUREAUX(19 / 25).

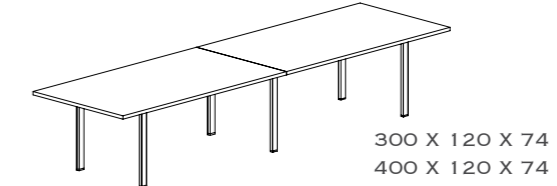

MESA DE REUNIÓN BASE (19 / 25).
RECTANGULAR DESK (19 / 25).
BUREAUX RECTANGULAIRE (19 / 25).

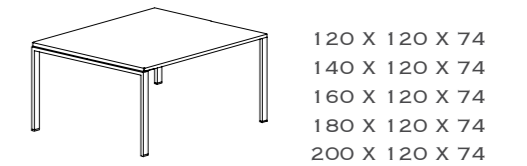

EXTENSIÓN PARA MESA DE REUNIÓN RECTANGULAR (19 / 25).
DESK EXTENSIONS (19 / 25).
PROLONGATIONS DE BUREAUX (19 / 25).

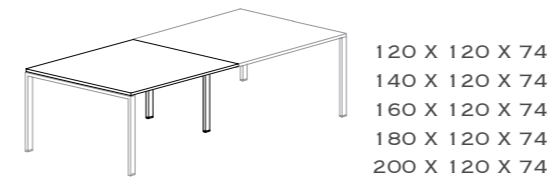

MESA RECTANGULAR (19 / 25).
RECTANGULAR DESK (19 / 25).
BUREAUX RECTANGULAIRE (19 / 25).

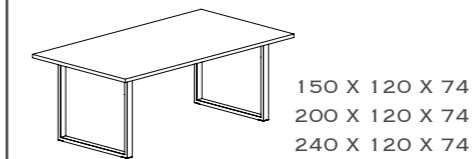

EXTENSIÓN MESA (19 / 25).
DESK EXTENTIONS(19 / 25).
PROLONGATIONS DE BUREAUX(19 / 25).

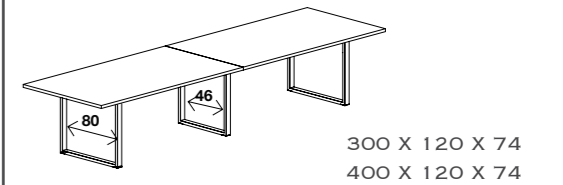

MESA CIRCULAR (19).
DESK EXTENSIONS (19).
PROLONGATIONS DE BUREAUX (19).

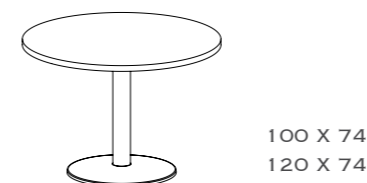

MESA CIRCULAR DE CRISTAL.
DESK EXTENSIONS GLASS.
PROLONGATIONS DE BUREAUX VERRE.

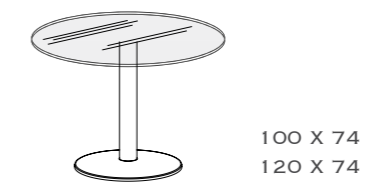



EXTREM

OPERATIVA

EXTREM TRANSMITE ELEGANCIA EN SU DISEÑO, CON SUS LATERALES DECLINADOS EN AMBOS SENTIDOS PRESENTANDO UN ASPECTO SINGULAR Y MODERNO.

EXTREM CONVEYS ELEGANCE IN ITS DESIGN, WITH ITS SIDES SLANTED IN BOTH DIRECTIONS PRESENTING A UNIQUE AND MODERN IMAGE.

EXTREM TRANSMET ÉLÉGANCE DANS SON DESIGN, AVEC SES CÔTÉS INCLINÉS DANS LES DEUX SENS PRÉSENTANT UNE IMAGE UNIQUE ET MODERNE.





EXTREM CON LUXE PERMITE QUE TUS PROYECTOS DESTAQUEN DEL RESTO. ES UNA EXCELTE ELECCIÓN PARA CREAR AMBIENTES DE DISEÑO. / LUXE EXTREM ALLOWS YOUR PROJECTS TO STAND OUT FROM THE REST. IT IS AN EXCELLENT CHOICE TO CREATE DESIGN ENVIRONMENTS. / EXTREM EN FINITION LUXE PERMET À VOS PROJETS DE SE DÉMARQUER. C'EST UN EXCELLENT CHOIX POUR CRÉER DES AMBIANCES D'INTÉRIEUR.



LA CALIDAD DE LOS MATERIALES ASÍ COMO LAS OPCIONES DE LOS SOBRES EN LUXE, CRISTAL Y MADERA HACEN LA SERIE ESPECIALMENTE MODERNA. / THE MATERIAL QUALITY AS WELL AS THE OPTIONS OF WORKING DESKTOP IN LUXE, GLASS OR WOOD MAKES THE RANGE ESPECIALLY MODERN. / LA QUALITÉ DES MATÉRIAUX AINSI QUE LES OPTIONS DES PLANS DE TRAVAIL EN LUXE, EN VERRE ET EN BOIS RENDENT LA SÉRIE PARTICULIÈREMENT MODERNE.





EXTREM ES UN PROGRAMA DE MESAS DE OFICINAS CON OBJETIVO DE APORTAR SOLUCIONES OPERATIVAS INCORPORANDO UN DISEÑO SINGULAR Y MATERIALES DE MÁXIMA CALIDAD. / EXTREM IS AN OFFICE DESK RANGE PRODUCED TO PROVIDE OPERATIONAL SOLUTIONS INCORPORATING DESIGN AND TOP QUALITY MATERIALS. / EXTREM EST UN SYSTÈME DE TABLES DE BUREAU QUI A COMME OBJECTIF D'OFFRIR DES SOLUTIONS OPÉRATIONNELLES INTÉGRANT UN DESIGN UNIQUE ET DES MATÉRIAUX DE QUALITÉ SUPÉRIEURE.









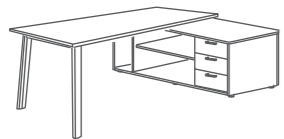



LAS MESAS DE REUNIÓN Y AUXILIARES PERMITEN CREAR ZONAS DE REUNIÓN PERSONALES. / THE MEETING AND AUXILIARY TABLES ALLOW YOU TO CREATE PERSONAL MEETING AREAS. / LES TABLES DE RÉUNION ET D'APPOINT PERMETTENT LA CRÉATION DE ZONES DE RÉUNION PERSONALISÉES.



PUESTOS INDIVIDUALES A TRAVÉS DE CONFIGURACIONES DE MESAS, POSIBILIDAD DE INCORPORAR UN ALA. / TABLE CONFIGURATIONS WITH THE POSSIBILITY TO INCORPORATE A TABLE TOP. / POSTES DE TRAVAIL INDIVIDUELS GRÂCE AUX DIFFÉRENTES OPTIONS D'AGENCEMENT ET LA POSSIBILITÉ D'INCORPORER UN RETOUR.

FÁCIL SISTEMA DE MONTAJE. SISTEMA DE MONTAJE SENCILLO Y RÁPIDO. / FAST AND EASY ASSEMBLY WITH MINIMAL. / SYSTÈME DE MONTAGE RAPIDE ET FACILE.

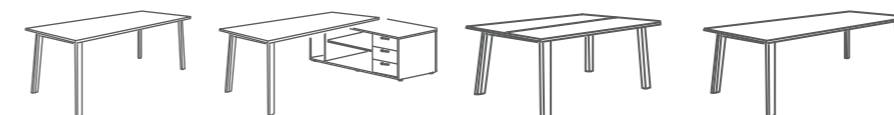

colección - collection

Mesa rectangular.
Rectangular desk.
Bureaux rectangulaire.



140 x 80 x 74
160 x 80 x 74
180 x 80 x 74
200 x 80 x 74

Mesa rectangular cristal.
Rectangular desk glass.
Bureaux rectangulaire verre.

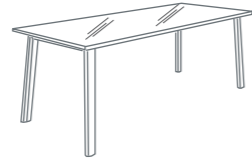

160 x 80 x 74
180 x 80 x 74
200 x 80 x 74

Ala para mesa rectangular.
Return desks.
Retour accrochés.



100 x 60 x 74
120 x 60 x 74

Mesa mueble ala.
Rectangular desk.
Bureaux rectangulaire.

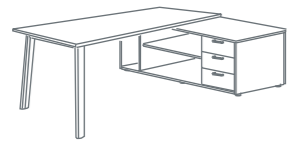

140 x 80 x 74
160 x 80 x 74
180 x 80 x 74
200 x 80 x 74

Mesa mueble ala cristal.
Desk for credenza glass.
Bureaux pour crédence verre.

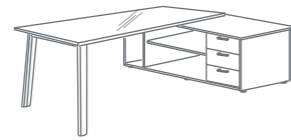

160 x 80 x 74
180 x 80 x 74
200 x 80 x 74

Mesa doble.
Bench desk.
Plans doubles.



140 x 164 x 74
160 x 164 x 74
180 x 164 x 74
200 x 164 x 74

Mesa de reunión rectangular.
Meeting table.
Table de réunion.



150 x 120 x 74
200 x 120 x 74

Mesade reunión circular.
Circular meeting table.
Table ronde de réunion.



100 x 74
120 x 74

Pantalla para mesa doble.
Screen for bench.
Ecran pour plan double.

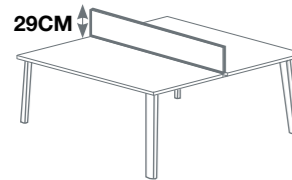

L120
L140
L160
L180
L200

Pantalla para mesa doble.
Screen for bench.
Ecran pour plan double.

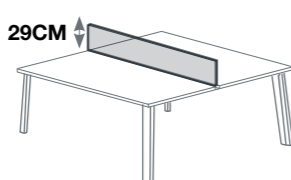

L120
L140
L160
L180
L200

Tapeta embellecedora enrasada.
Aluminium lid.
Enjouliveur en aluminium.

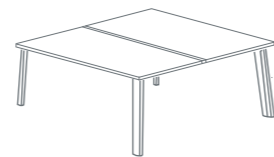

L120
L140
L160
L180
L200

Faldón laminado.
Laminated modesty panels.
Voiles de fond.

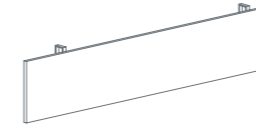

L140
L160
L180
L200

Faldón metálico.
Metal modesty panel.
Voiles de fond métalliques.

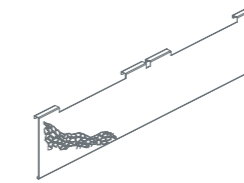

L140
L160
L180
L200

Soporte Cpu.
CPU support.
Support unite centrale.

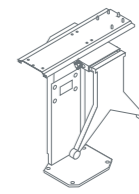

Bandeja pasa cables horizontal.
Horizontal cable tray.
Goulotte horizontale.

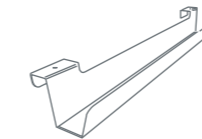

L120
L140
L160
L180
L200

Bandeja pasa cables horizontal.
Horizontal cable tray.
Goulotte horizontale.

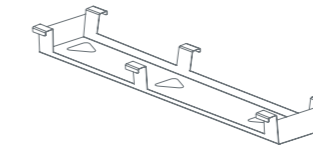

L120
L140
L160
L180
L200

Pasacables vertical tubular.
Vertical cable collector.
Accessoire vertical.

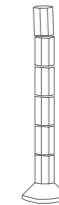

L120
L140
L160
L180
L200



LOG_IN

ELEVABLE

MESA ELEVABLE DISPONIBLE EN LOS ACABADOS EXCLUSIVOS DE LUXE BY ALVIC, OFRECIENDO UN RESULTADO ÚNICO.

ELECTRICAL TABLE AVAILABLE IN THE EXCLUSIVE FINISHES OF LUXE BY ALVIC, OFFERING A UNIQUE RESULT.

TABLE ÉLECTRIQUE DISPONIBLE DANS LES FINITIONS EXCLUSIVES DE LUXE BY ALVIC, OFFRANT UN RÉSULTAT UNIQUE.

Log_in

MESA ELEVABLE



Log_in

MESA ELEVABLE



LA COLUMNA DISPONE DE UN DISEÑO PRÁCTICO QUE FACILITA EL SISTEMA DE CABLEADO POR LO QUE PERMITE TENER ESPACIOS ORDENADOS.

THE COLUMN HAS A PRACTICAL DESIGN THAT FACILITATES THE WIRING SYSTEM SO IT ALLOWS TO HAVE ORDERED SPACES

LA COLONNE A UNE CONCEPTION PRATIQUE QUI FACILITE LE SYSTÈME DE CÂBLAGE, AINSI ELLE PERMET D'AVOIR DES ESPACES ORDONNÉS.





colección - collection

MESA ELEVABLE
ELEVABLE TABLE
TABLE ÉLÉVATRICE



PASACABLES VERTICAL EXTENSIBLE
EXTENSIBLE VERTICAL CABLE COLLECTOR
ACCESSOIRE POUR DESCENTE CABLES VERTICAL EXTENSIBLE

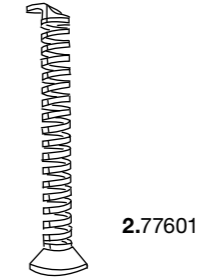

ALTURA MÍNIMA 61 Y MÁXIMA 125.

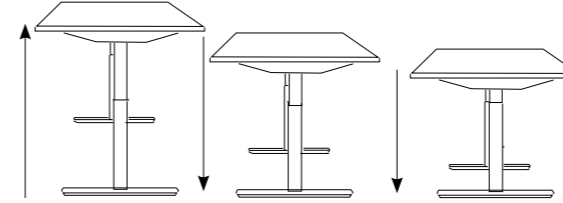



LOGIN

OPERATIVA

COLECCIÓN OPERATIVA QUE SE ADAPTA A LAS DIFERENTES NECESIDADES DE TRABAJO, CON UN SISTEMA DE CABLEADO INTERNO.

OPERATIONAL COLLECTION THAT ADAPTS TO DIFFERENT WORK NEEDS, WITH A STRUCTURAL WIRING SYSTEM

UNE COLLECTION OPÉRATIONELLE QUI S'ADAPTE AUX DIFFÉRENTS BESOINS DE TRAVAIL, AVEC UN SYSTEM DE CÂBLAGE INTERNE.



LA SERIE SE IDENTIFICA POR LA ESTÉTICA LIMPIA DE SU COLUMNA. SU DISEÑO TRANSMITE UN CONCEPTO PRÁCTICO Y ELEGANTE DEL ESPACIO DE TRABAJO.

THE SERIES IDENTIFIES THEMSELVES FOR THE CLEAN AESTHETICS OF ITS COLUMNS. ITS DESIGN CONFERS A PRACTICAL AND ELEGANT CONCEPT OF THE WORKING SPACE.

LA SÉRIE S'IDENTIFIE PAR SON L'ESTHÉTIQUE PROPRE SÛR SA COLONNE. SON DESSIN TRANSMET UN CONCEPT PRATIQUE ET ÉLÉGANT DE L'ESPACE DE TRAVAIL.



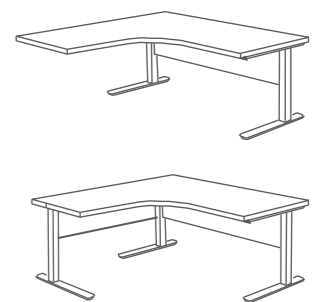
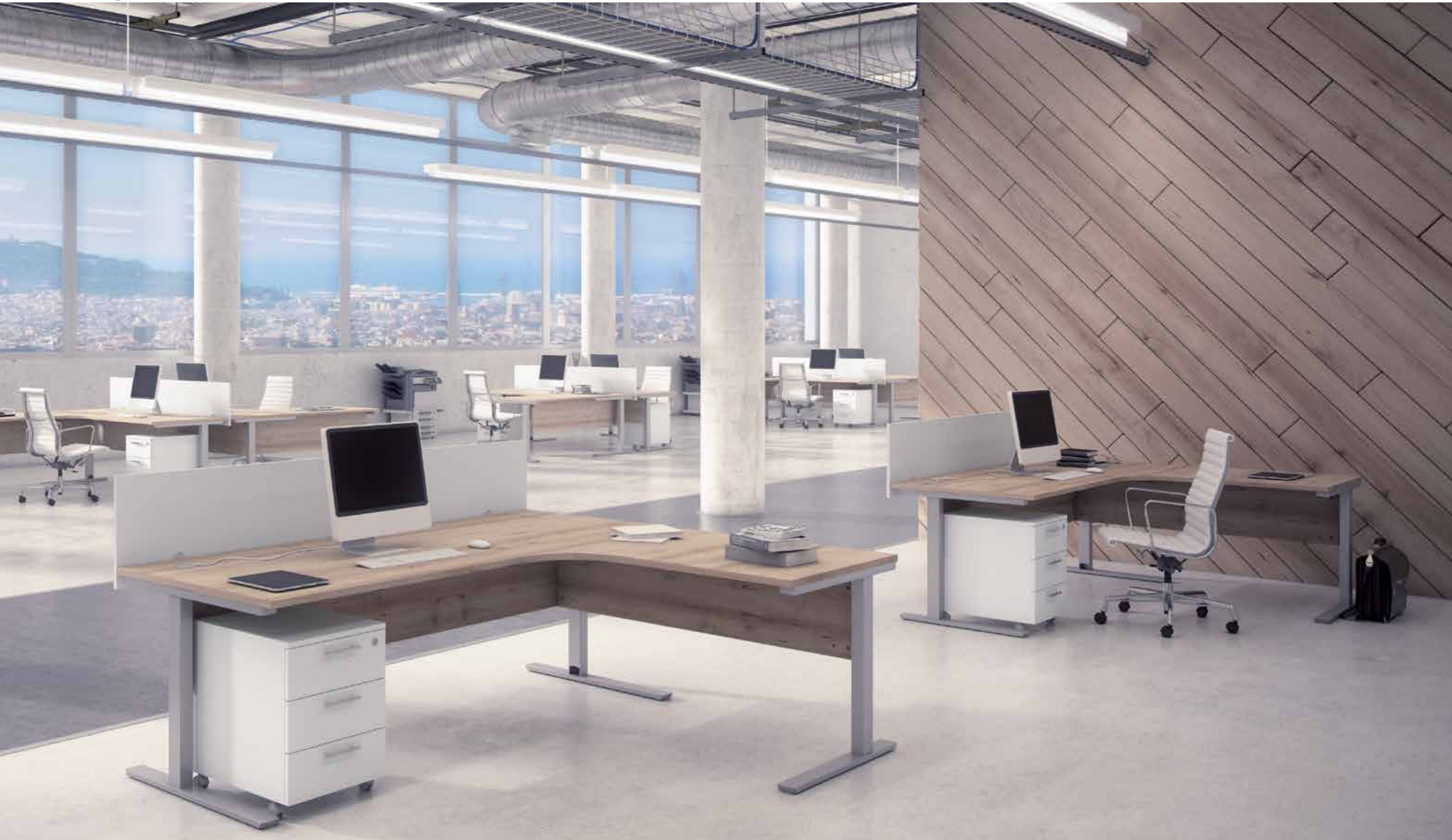

FORMA SENCILLA, LÍNEAS RECTAS, CON UNA AMPLIA VARIEDAD DE COMPLEMENTOS DISPONIBLES. APORTA SOLUCIONES QUE SE ADAPTAN A DIFERENTES NECESIDADES: OFICINAS, ESCUELAS, UNIVERSIDADES Y BIBLIOTECAS

SIMPLE DESIGN, STRAIGHT LINES, WITH A WIDE VARIETY OF ACCESSORIES AVAILABLE. IT PROVIDES SOLUTIONS THAT ADAPT TO DIFFERENT NEEDS: OFFICES, SCHOOLS, UNIVERSITIES AND LIBRARIES

FORME SIMPLE, LIGNES DROITES, AVEC UNE GRANDE VARIÉTÉ D'ACCESSOIRES DISPONIBLES. FOURNIT DES SOLUTIONS QUI S'ADAPTENT À DIFFÉRENTS BESOINS: BUREAUX, ÉCOLES, UNIVERSITÉS ET BIBLIOTHÈQUES.





MESA RECTANGULAR.
RECTANGULAR DESK.
BUREAU RECTANGULAIRE.

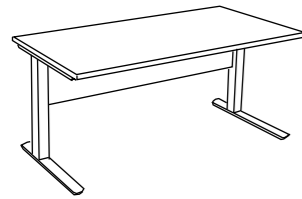

80 x 80 x 75
120 x 80 x 75
140 x 80 x 75
160 x 80 x 75
180 x 80 x 75

ALA PARA MESA DE 80.
RETURN DESK FOR 80.
RETOUR ACCROCHÉ POUR BUREAUX P80.

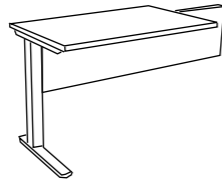

80 x 60 x 75
100 x 60 x 75
120 x 60 x 75

MESA RADIAL.
RADIAL DESK.
BUREAU COURBE.

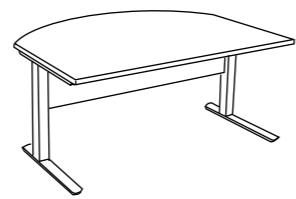

160 x 100 x 75
180 x 100 x 75

MESA 90°.
90° COMPACT DESK.
PLAN COMPACT 90°.

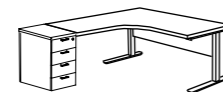
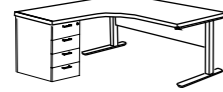
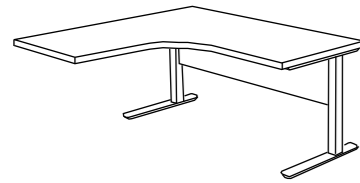

140 x 120 x 75
160 x 120 x 75
160 x 140 x 75
160 x 160 x 75
180 x 120 x 75
180 x 140 x 75
180 x 160 x 75

ALA BUC DE 60.
RETURN PEDESTAL P60.
RETOUR ACCROCHÉ POUR CAISSON PORTEUR.

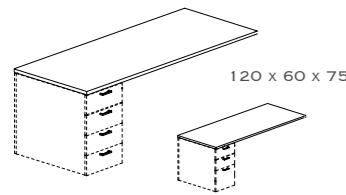

120 x 60 x 75

BANDEJA PASA CABLES HORIZONTAL.
HORIZONTAL CABLE TRAY.
GOULOTTE HORIZONTALE.

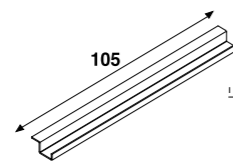

L105xW7,3xH2,9

BANDEJA PASA CABLES HORIZONTAL.
HORIZONTAL CABLE TRAY.
GOULOTTE HORIZONTALE.

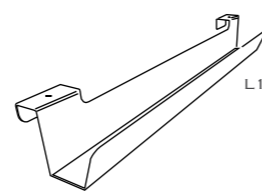

L105xW7,3xH2,9

PANTALLA LATERAL.
SIDE SCREENS FOR INDIVIDUAL DESK.
ÉCRANS LATÉRAUX.

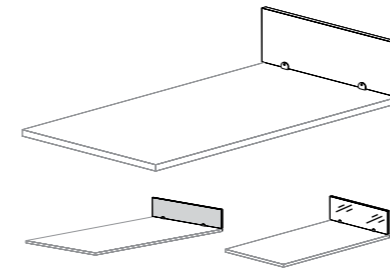

60 x 29 x 1,9
80 x 29 x 1,9

PANTALLA FRONTAL.
FRONTAL SCREENS.
ÉCRANS FRONTAUX.

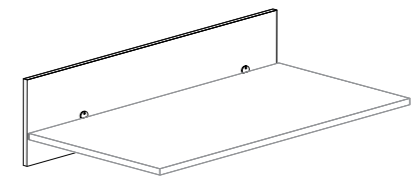

120 x 35,6 x 1,9
140 x 35,6 x 1,9
160 x 35,6 x 1,9
180 x 35,6 x 1,9
200 x 35,6 x 1,9

PANTALLA FRONTAL DE METACRILATO.
METHACRYLATE FRONTAL SCREENS.
ÉCRANS FRONTAUX EN MÉTHACRYLATE.

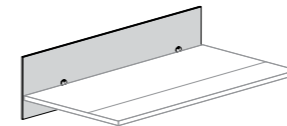

120 x 35,6 x 1,9
140 x 35,6 x 1,9
160 x 35,6 x 1,9
180 x 35,6 x 1,9

SOPORTES PARA PANTALLAS.
ADDITIONAL BRACKETS.
SUPPORTS ADDITIONNELS.

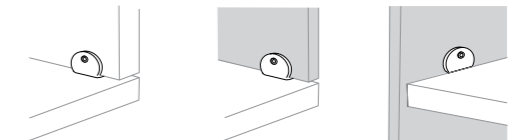

EXTENSIÓN SEMICIRCULAR.
SEMICIRCULAR EXTENSION.
LIAISON DEMI-RONDE.

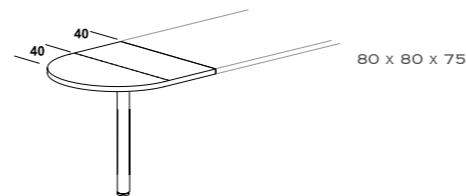

80 x 80 x 75

UNIÓN ANGULAR 90° 80 / 80.
90°CONNECTOR 80/80.
ANGLE LIAISON 90° 80 / 80.

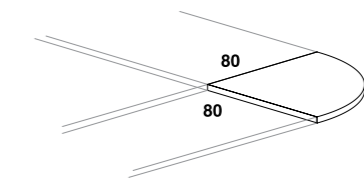

80 x 80 x 2,5



NOVA

OPERATIVA

SISTEMA DE MONTAJE FÁCIL, LA ESTRUCTURA YA SE RECIBE MONTADA.

EASY ASSEMBLING SYSTEM, THE STRUCTURE IS ALREADY ASSEMBLED.

SYSTÈME DE MONTAGE FACILE, LA STRUCTURE EST DÉJÀ ASSEMBLÉE.



MESAS DOBLES, LA SOLUCIÓN PERFECTA PARA EL TRABAJO EN EQUIPO. CUBRE LAS NECESIDADES DE PUESTOS DOBLES A TRAVÉS DE CONFIGURACIONES DE MESAS DE 70CM. / DOUBLE TABLES, THE PERFECT SOLUTION FOR TEAMWORK. THEY COVER DOUBLE WORKSTATION NEEDS WITH 70CM TABLE CONFIGURATIONS. / LES TABLES DOUBLES, LA SOLUTION PARFAITE POUR LE TRAVAIL EN ÉQUIPE. ELLES COUVRENT LES BESOINS DE POSTES DE TRAVAIL DOUBLE EN UTILISANT DES CONFIGURATIONS DE TABLE DE 70CM.



FORMA SENCILLA, LÍNEAS RECTAS Y PURAS. PRESENTA UNA VARIEDAD DE COMPLEMENTOS FALDONES Y SEPARADORES. DE MONTAJE RÁPIDO. CUBRE LAS NECESIDADES DE PUESTOS INDIVIDUALES A TRAVÉS DE CONFIGURACIONES DE MESAS DE FONDO 80CM CON POSIBILIDAD DE INCORPORAR UN ALA. APORTA SOLUCIONES QUE SE ADAPTAN A DIFERENTES NECESIDADES, OFICINAS, ESCUELAS, UNIVERSIDADES Y BIBLIOTECAS. / SIMPLE SHAPE, STRAIGHT AND PURE LINES, WITH A BIG ACCESSORIES RANGE LIKE TABLE SKIRTS AND TABLE SEPARATORS. FAST AND EASY ASSEMBLY. COVER THE INDIVIDUAL WORKSTATION NEEDS WITH 80CM TABLE CONFIGURATIONS WITH THE POSSIBILITY TO INCORPORATE A TABLE TOP. PROVIDES SOLUTIONS FOR OFFICES, SCHOOLS, UNIVERSITIES AND LIBRARIES. / FORME SIMPLE, LIGNES DROITES ET PURES. EXTREM OFFRE UNE GRANDE VARIÉTÉ D'ACCESSOIRES, DE VOILES DE FOND ET DE SÉPARATEURS. MONTAGE RAPIDE. CE SYSTÈME DE TABLES COUVRE LES BESOINS DES POSTES DE TRAVAIL INDIVIDUELS DE PROFONDEUR DE 80CM AVEC LA POSSIBILITÉ D'INTÉGRER UN RETOUR. IL OFFRE DES SOLUTIONS ADAPTÉES AUX DIFFÉRENTS BESOINS DES BUREAUX, DES ÉCOLES, DES UNIVERSITÉS ET DES BIBLIOTHÈQUES.





MESA CON MÚLTIPLES POSIBILIDADES DE ADAPTACIÓN. ESTRUCTURA DISPONIBLE EN ALUMINIO Y BLANCO. / TABLE WITH MULTIPLE ADAPTATION POSSIBILITIES. STRUCTURE AVAILABLE IN ALUMINIUM OR WHITE. / TABLE AVEC DE MULTIPLES POSSIBILITÉS D'AGENCEMENTS. STRUCTURE MÉTALLIQUE DISPONIBLE EN ALUMINIUM ET EN BLANC.



LAS FORMAS SENCILLAS Y LA UTILIZACIÓN DE ACABADOS COMO EL LUXE COMBINADOS CON LAS MELAMINAS CONVIERTEN UNA CONFIGURACIÓN BÁSICA CON MESAS RECTAS EN UN ESPACIO MODERNO Y ACTUAL. / THE SIMPLE SHAPES AND THE USE OF FINISHES LIKE LUXE COMBINED WITH MELAMINE TURN A BASIC CONFIGURATION WITH STRAIGHT TABLES INTO A MODERN AND CURRENT SPACE. / LES FORMES SIMPLES ET L'UTILISATION DE FINITIONS COMME LE LUXE, COMBINÉ AVEC LES MÉLAMINES, PERMETTENT DE TRANSFORMER UNE CONFIGURATION DE BASE AVEC DES TABLES DROITES EN UN ESPACE MODERNE ET ACTUEL.





FÁCIL SISTEMA DE MONTAJE. SISTEMA DE MONTAJE SENCILLO Y RÁPIDO MEDIANTE EL USO MÍNIMO DE TORNILLERÍA. / FAST AND EASY ASSEMBLY WITH MINIMAL USE OF SCREWS. / MONTAGE FACILE. SYSTÈME DE MONTAGE RAPIDE ET FACILE EN UTILISANT LE MINIMUM DE QUINCAILLERIE.



FORMA SENCILLA. LÍNEAS RECTAS Y PURAS. CUBRE LAS NECESIDADES DE PUESTOS INDIVIDUALES A TRAVÉS DE CONFIGURACIONES DE MESAS, POSIBILIDAD DE INCORPORAR UN ALA. / SIMPLE SHAPE, STRAIGHT AND PURE LINES. COVER THE INDIVIDUAL WORKSTATION NEEDS THROUGH DIFERENT TABLE CONFIGURATIONS WITH THE POSSIBILITY TO INCORPORATE A TABLE TOP. / FORMES SIMPLÉS, LIGNES DROITES ET PURES. RÉPOND AUX BESOINS DE POSTES DE TRAVAIL INDIVIDUELS GRÂCE AUX DIFFÉRENTES OPTIONS D'AGENCEMENT ET LA POSSIBILITÉ D'INCORPORER UN RETOUR.





NEW PANO

OPERATIVA

COLECCIÓN CLÁSICA Y ELEGANTE, CON SUS AMPLIAS POSIBILIDADES PERMITE EQUIPAR CUALQUIER PUESTO DE TRABAJO.

CLASSIC AND ELEGANT COLLECTION, WITH ITS WIDE POSSIBILITIES ALLOWS TO EQUIP ANY WORK PLACE.

COLLECTION CLASSIQUE ET ÉLÉGANTE, AVEC DE LARGE POSSIBILITÉS, PERMET D'ÉQUIPER TOUT TYPE DE POSTE DE TRAVAIL.



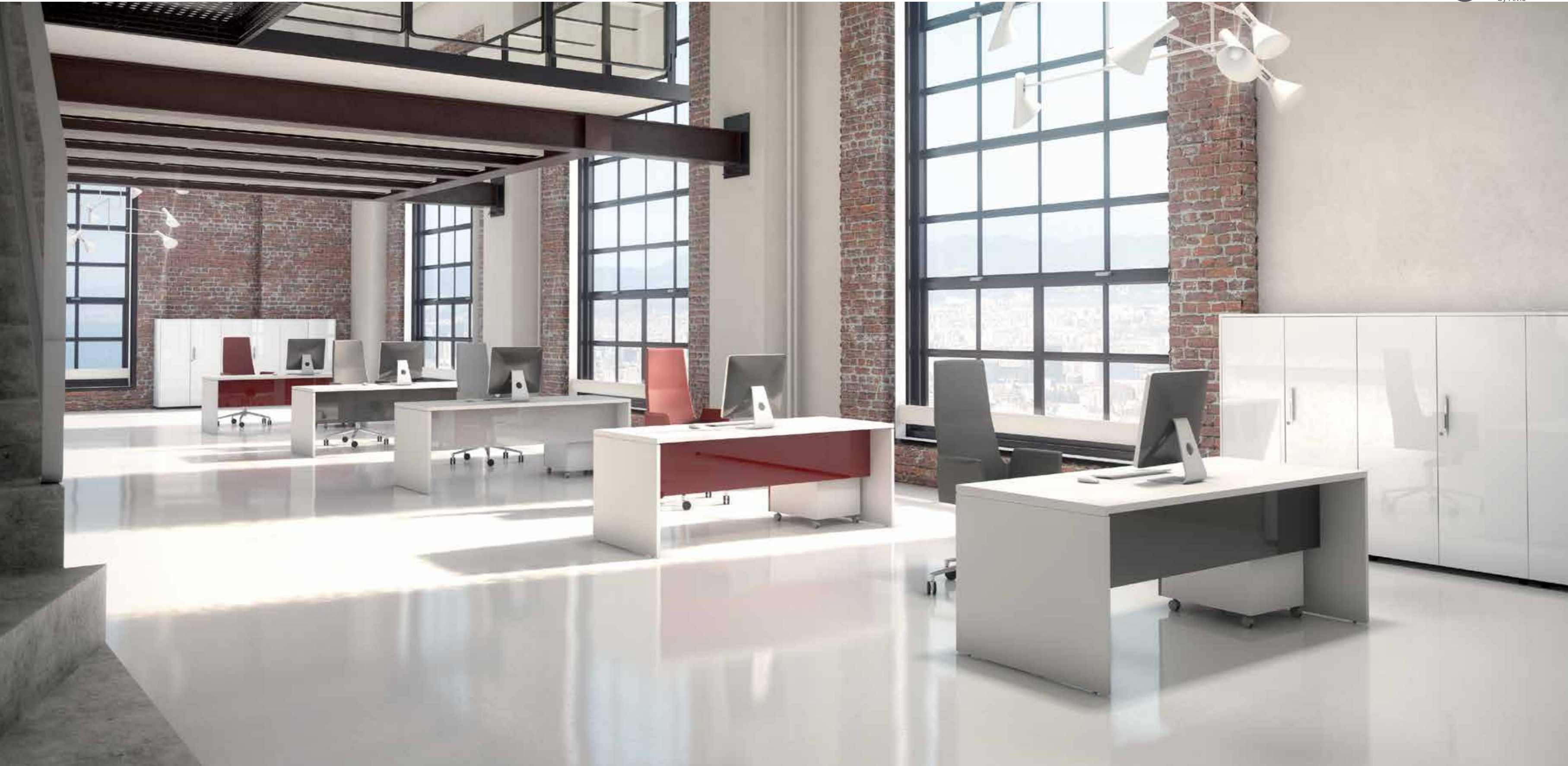





UNA CONFIGURACIÓN DE CUATRO PUESTOS DE TRABAJO CON PUNTOS INFORMÁTICOS Y
ÁNGULOS DE CONEXIÓN PARA USO COMÚN. / A WORKSTATION FOR FOUR PEOPLE WITH
COMPUTER POINTS AND ANGLES OF CONNECTION FOR COMMON USE. / UNE CONFIGURATION
DE QUATRE POSTES DE TRAVAIL AVEC DES POINTS INFORMATIQUES ET ANGLES DE
CONNECTION POUR DES USAGES COMMUNS.

new
PANO



DESIGN: (BILAMINADO) GRIS, GREY, GRIS.
DESIGN: (BILAMINADO) BLANCO, WHITE, BLANC.
DESIGN: (BILAMINADO) ROBLE, OAK, CHÊNE CLAIRE.



DESIGN: (BILAMINADO) NOGAL, WALNUT, NOYER.

MESA RECTANGULAR DE 80.
RECTANGULAR DESK P80.
BUREAU RECTANGULAIRE P80.

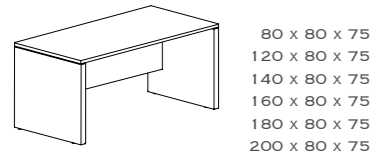

EXTENSIÓN MESA DE 80.
EXTENTION DESK P80.
PROLONGATION DE BUREAU P80.

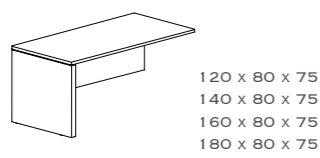

MESA AUXILIAR RECTA DE 60.
AUXILIARY DESK P60.
RETOUR P60.

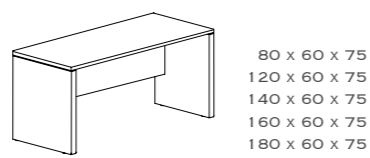

EXTENSIÓN MESA DE 60.
EXTENTION DESK P60.
PROLONGATION DE RETOUR P60.

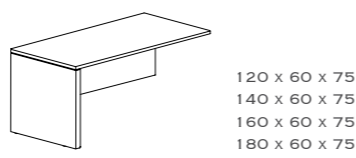

ALA DE 60.
RETURN DESK P60.
RETOUR ACCROCHÉ P60.

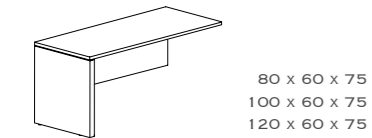

ALA BUC DE 60.
RETURN PEDESTAL P60.
RETOUR ACCROCHÉ POUR CAISSON PORTEUR.

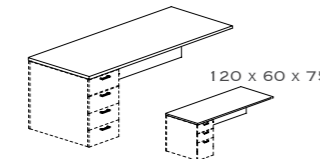

MESA RADIAL.
RADIAL DESK.
BUREAU COURBE.

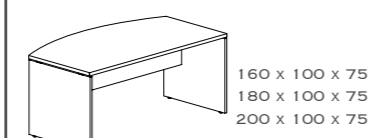

MESA BUC.
PEDESTAL DESK.
BUREAU POUR CAISSON PORTEUR.

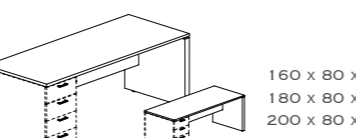

EXTENSIÓN BUC.
EXTENTION PEDESTAL.
PROLONGATION POUR CAISSON PORTEUR.

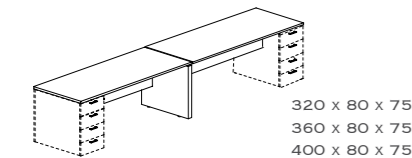

MESA ARMARIO ALA.
RETURN CUPBOARD DESK.
BUREAU AVEC MEUBLE RETOUR.

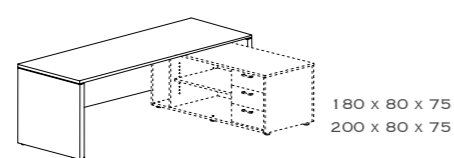

MUEBLE ALA.
RETURN CUPBOARD.
MEUBLE RETOUR.

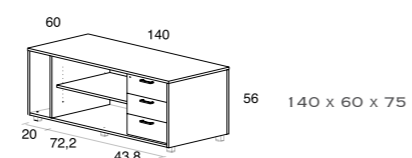

MESA DOBLE.
BENCH DESK.
PLAN DOUBLE.

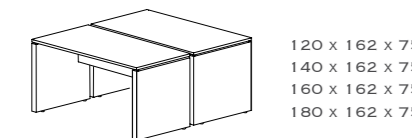

EXTENSIÓN MESA DOBLE.
EXTENTION FOR BENCH DESK.
PROLONGATION DOUBLE.

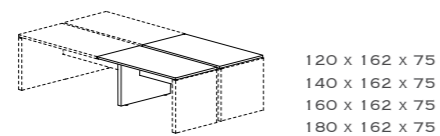

MESA DOBLE CON TOP ACCESS.
BENCH DESK WITH TOP ACCESS.
PLAN DOUBLE AVEC TOP ACCESS.

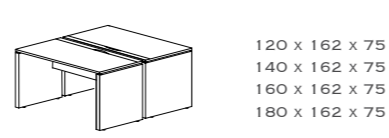

MINI BENCH
MINI BENCH
PLAN DOUBLE MINI BENCH.

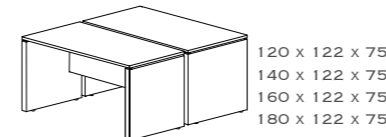

EXTENSIÓN MINI BENCH CON PATA RETRAÍDA.
MINI BENCH WITH RETRACTED LEG.
PROLONGATION MINI BENCH AVEC PIED RETRÉ.

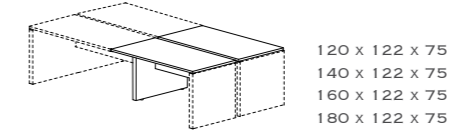

ALA CENTRAL PARA MESA DOBLE Y MINI BENCH.
CENTRAL RETURN FOR BENCH DESK / MINI BENCH.
RETOUR ACCROCHÉ CENTRAL POUR PLAN DOUBLE ET MINI BENCH.

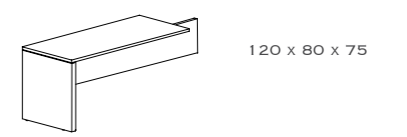

MESA 90° PARA COMPOSER.
90° DESK TO COMPOSE.
PLAN COMPACT 90° (À COMPOSER).

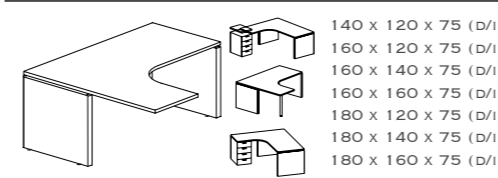

MESA 90° DOBLE PARA COMPOSER.
90° DOUBLE DESK TO COMPOSE.
PLAN COMPACT 90° DOUBLES (À COMPOSER).

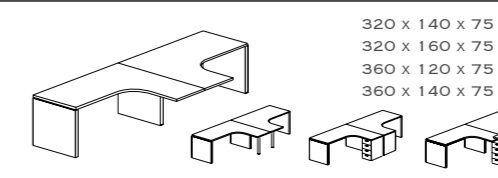

MESA 90° DOBLE PARA COMPOSER.
90° DOUBLE DESK TO COMPOSE.
PLAN COMPACT 90° + PROLONGATION DOUBLE (À COMPOSER).

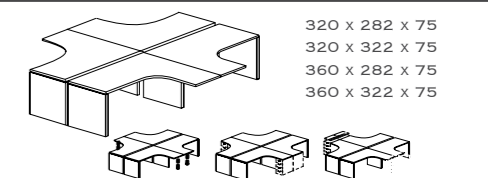

MESA DE JUNTAS.
MEETING TABLE.
TABLE DE RÉUNION.

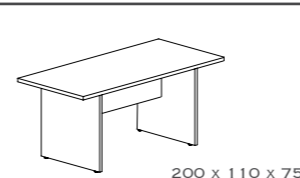

MESA DE JUNTAS DOBLE.
DOUBLE MEETING TABLES.
TABLE DE RÉUNION + PROLONGATION.

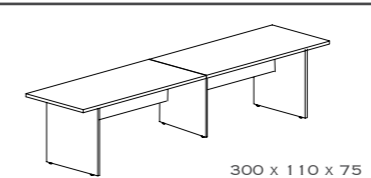

MESA DE JUNTAS OVALADA.
OVAL MEETING TABLE.
TABLE DE RÉUNION OVALE.

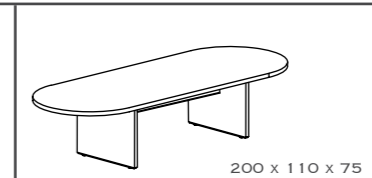

MESA DE JUNTAS SEMICIRCULAR.
SEMI-CIRCLE MEETING TABLE.
TABLE DE RÉUNION SEMI-CIRCULAIRE.

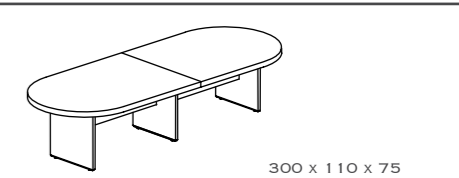

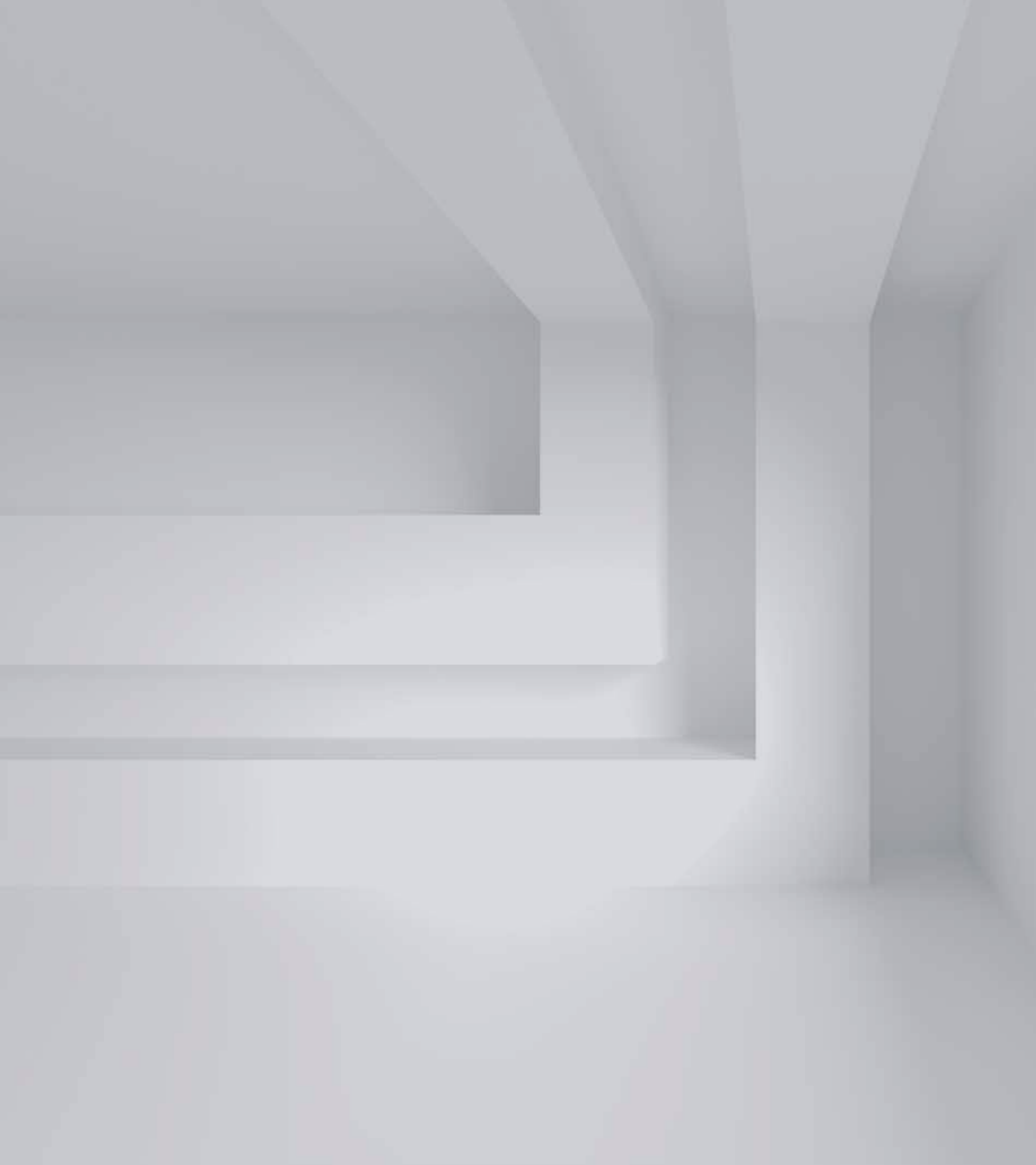

PREMIER

OPERATIVA

PREMIER ES UNA GAMA OPERATIVA QUE INCLUYE MESAS, CAJONERAS Y ARMARIOS.

PREMIER IS AN OPERATIVE RANGE THAT INCLUDES TABLES, DRAWERS AND CABINETS.

PREMIER EST UNE GAMME OPÉRATIONNELLE QUI COMPRENDE TABLES, CAISSONS ET ARMOIRES.





DESIGN: (BILAMINADO) BLANCO, WHITE, BLANC.



DESIGN: (BILAMINADO) BLANCO, WHITE, BLANC. (BILAMINADO) ALUMINIO, ALUMINIUM.

UNA CONFIGURACIÓN CLÁSICA Y ELEGANTE PARA PUESTOS DE TRABAJO INDIVIDUALES. / A CLASSIC & ELEGANT SET-UP FOR INDIVIDUAL WORK ENVIRONMENTS. / UNE CONFIGURATION CLASSIQUE ET ÉLÉGANTE POUR POSTES DE TRAVAIL INDIVIDUELS.



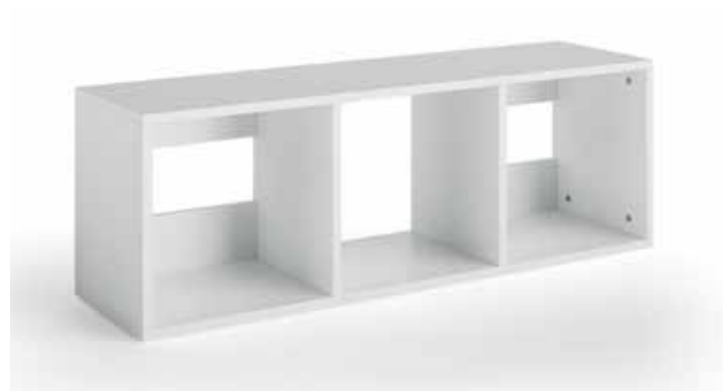

MESA RECTANGULAR.
RECTANGULAR DESK.
BUREAU RECTANGULAIRE.

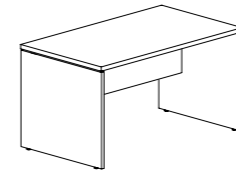

120 x 80 x 75
140 x 80 x 75
160 x 80 x 75

ALA.
RETURN DESK.
RETOUR ACCROCHÉ.

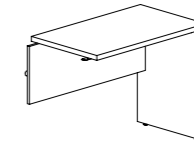

100 x 60 x 75



ESTANTERÍA KUBO
RECTANGULAR DESK.
BUREAU RECTANGULAIRE.

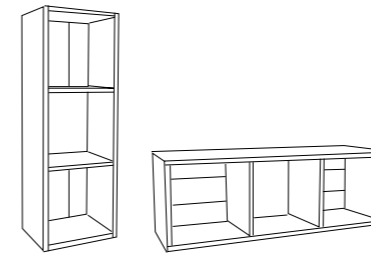

121,6 x 41,8 x 35,0

ESTANTERÍA KUBO
RETURN DESK.
RETOUR ACCROCHÉ.

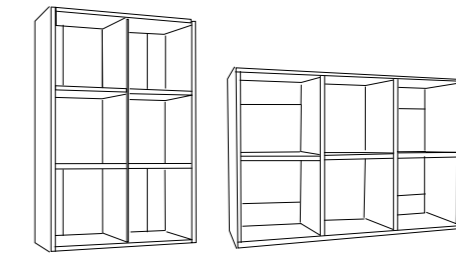

121,6 x 81,6 x 35,0



ESTANTERÍA KUBO
RECTANGULAR DESK.
BUREAU RECTANGULAIRE.

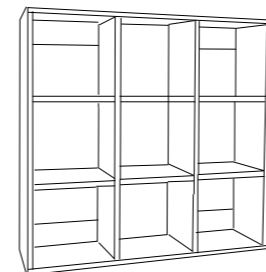

121,6 x 121,6 x 35,0

CAJONERA 3 CAJONES KUBO.
RETURN DESK.
RETOUR ACCROCHÉ.

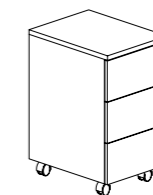

33 x 45 x 55





COLECTIVIDADES

OPERATIVA

GAMA QUE CON SUS DIFERENTES POSIBILIDADES, PERMITE COMPLETAR CUALQUIER PROYECTO.

THIS RANGE AND ITS DIFFERENT POSSIBILITIES, ALLOWS TO COMPLETE ANY PROJECT.

CETTE GAMME ET SES DIFFÉRENTS POSSIBILITÉS, PERMETS DE COMPLÉTER TOUTE TYPE DE PROJET.





UNA PROPUESTA VERSÁTIL QUE OFRECE MÚLTIPLES POSIBILIDADES DE CRECIMIENTO. / A VERSATILE OPTION THAT OFFERS MULTIPLE GROWTH POSSIBILITIES. / UNE PROPOSITION UNIVERSELLE QUI OFFRE DE MULTIPLES POSSIBILITÉS DE CROISSANCE.



MESA PLEGABLE:

OPCIÓN MESA PLEGABLE O FIJA. UNA PROPUESTA QUE PERMITE DIFERENTES NECESIDADES EN EL ENTORNO DE LA FORMACIÓN COMO SALAS DE ESTUDIO, DE CONFERENCIAS, AULAS DE FORMACIÓN Y BIBLIOTECAS.

FOLDING TABLE:

FOLDING TABLE OR FIXED OPTION. A PROPOSAL ALLOWING DIFFERENT NEEDS IN THE TRAINING ENVIRONMENT SUCH AS STUDY ROOMS, CONFERENCE ROOMS, CLASSROOMS AND LIBRARIES.

TABLE PLIANTE:

TABLE PLIANTE OU FIXE. UNE PROPOSITION QUI PERMET DIFFÉRENTES PROPOSITIONS DANS L'ENVIRONNEMENT DE FORMATION, DES SALLES D'ÉTUDE, DE CONFÉRENCES, SALLES DE FORMATION ET BIBLIOTHÈQUES.



MESA COLECTIVIDADES.
CONFERENCE DESKS.
TABLES POLYVALENTES.

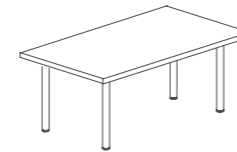

80 x 60 x 75
100 x 60 x 75
120 x 60 x 75

PATA H75 PARA COMPOSER.
LEG H75 TO COMPOSE.
PIED CYLINDRIQUE H75 À COMPOSER.

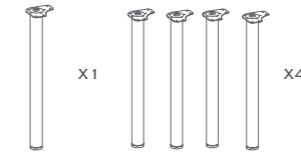

UNIÓN ANGULAR DE 90° 60/60.
90° ANGLE UNION 60/60 LEFT.
ANGLE DE LIAISON 90° 60/60.

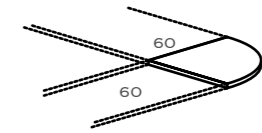

UNIÓN ELÍPTICA 120
SEMI-CIRCULAR UNION 120.
LIAISON DEMI-RONDE 120.



120 x 50 x 75

EJEMPLOS DE COMPOSICIONES.
COMPOSITION EXAMPLES.
EXEMPLES D'AMÉNAGEMENT.

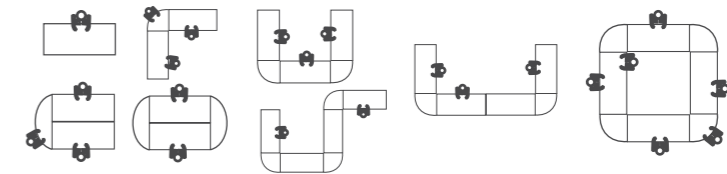

MESA CAFÉ
COFFEE TABLE
BUREAU CAFÉ

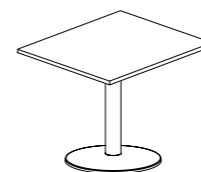

L70 x W70 x H75

MESA ESPERA
WAITING TABLE.
TABLE D'ATTENTE.

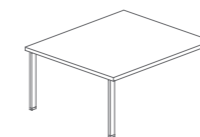

L60 x W60 x H40

MESA PLEGABLE
FOLDING TABLE.
TABLE PLIANTE



L60 x W120 x H75
L60 x W160 x H75

MESA ELEVABLE
ELEVABLE TABLE
TABLE ÉLÉVATRICE



140 x 80
160 x 80
180 x 80
200 x 80

PASACABLES VERTICAL EXTENSIBLE
EXTENSIBLE VERTICAL CABLE COLLECTOR
ACCESSOIRE POUR DESCENTE CABLES VERTICAL EXTENSIBLE



2.77601



AVANT

MOSTRADORES

MOSTRADOR MODERNO, FUNCIONAL Y CON UN AÑADIDO DE DISEÑO, PODEMOS AFIRMAR QUE SE ADAPTA A CUALQUIER ENTORNO.

MODERN COUNTER, FUNCTIONAL AND WITH AN ADDED OF DESIGN, WE CAN SAY THAT IT ADAPTS TO ANY ENVIRONMENT.

BANQUE D'ACCUEIL MODERNE, FONCTIONNELLE ET AVEC UN DESIGN AJOUTÉ, S'ADAPTE À TOUT TYPE ENVIRONNEMENT.





LA IMPORTANCIA DEL DETALLE / THE IMPORTANCE OF DETAILS / L'IMPORTANCE DU DETAIL.

DETALLES COMO LA UNIÓN DE LOS CANTOS Y LA CALIDAD DE LOS ACABADOS MASCAN LA DIFERENCIA Y LE OTORGAN UN ASPECTO IMPECABLE DE ALTA CALIDAD. / DETAILS SUCH AS THE FINISHING OF THE PIECES AND THE QUALITY OF THE MATERIALS MAKE THE DIFFERENCE AND GIVE AN UNBLEMISHED IMAGE TO THE PRODUCT. / DES DÉTAILS TELS COMME, LES FINITIONS DES BORDS ET LA FINESSE DES MATÉRIAUX, MARQUENT LA DIFFÉRENCE DONNANT UNE APPARENCE IMPECCABLE ET DE HAUTE QUALITÉ.



AVANT ESTÁ PREPARADO PARA INSTALAR UNA O DOS TIRAS DE LED DE INTENSIDAD REGULABLE SITUADAS EN LA PARTE INFERIOR DE LOS FRONTEALES DECORATIVOS. / AVANT, IS PREPARED TO INSTALL ONE OR TWO DIMMABLE LED STRIPS LOCATED IN THE LOWER PART OF THE FRONT DECORATIVE PANEL, PROVIDING A MORE SOPHISTICATED STYLE. / AVANT, EST PRÊT À INSTALLER UNE OU DEUX BANDES DE LED D'INTENSITÉ RÉGLABLE, SITUÉES DANS LA PARTIE INFÉRIEURE DES FRONTEAUX DÉCORATIFS DU COMPTOIR, OFFRANT UN STYLE SOPHISTIQUÉ.

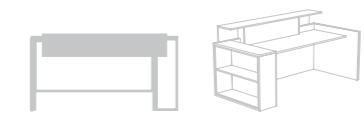

UN LUGAR DONDE LAS NECESIDADES DE ADMINISTRACIÓN, DE ATENCIÓN, DE ALMACENAJE, DE ORDEN Y DE IMAGEN COBRAN UNA ESPECIAL RELEVANCIA. / A PLACE WHERE THE NEEDS OF ADMINISTRATION, ATTENTION, ORDER AND IMAGE HAVE A SIGNIFICANT IMPORTANCE. / UN LIEU OÙ LES BESOINS D'ADMINISTRATION, D'ATTENTION, DE STOCKAGE, D'ORDRE ET D'IMAGE ONT UNE IMPORTANCE PARTICULIÈRE.

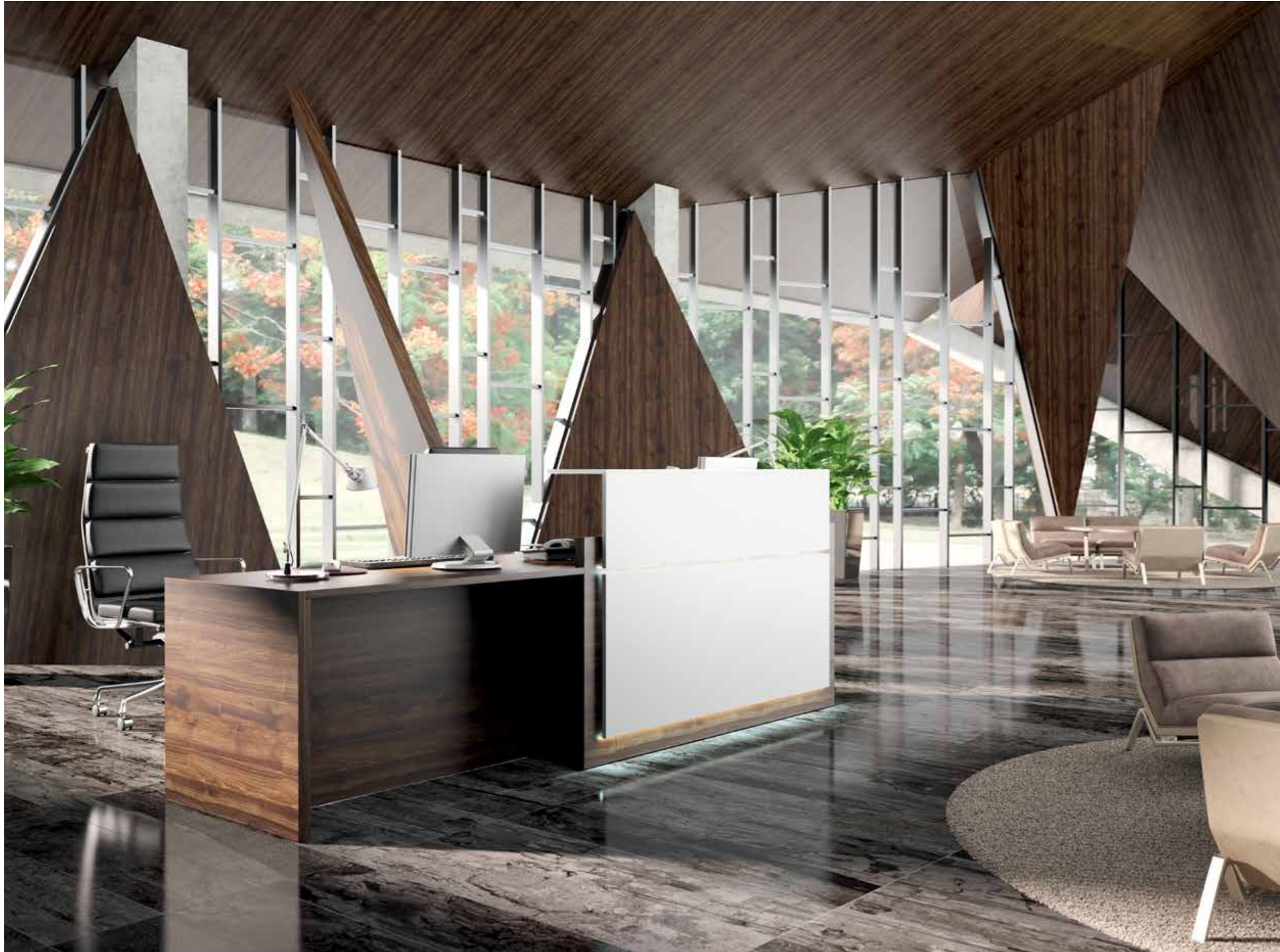

AVANT DISPONE DE ATENCIÓN PERSONALIZADA FRONTAL Y LATERAL FACILITANDO UNA MAYOR PROXIMIDAD EN LA COMUNICACIÓN. / AVANT, HAVE AS STANDARD CONFIGURATIONS, FRONTAL AND LATERAL PERSONALIZED ATTENTION COUNTER, WHICH FACILITATES A CLOSER COMMUNICATION. / AVANT, COMPTE AVEC UNE ATTENTION PERSONNALISÉE FRONTALE ET LATÉRALE, FACILITANT AINSI UNE MEILLEURE PROXIMITÉ DANS LA COMMUNICATION.

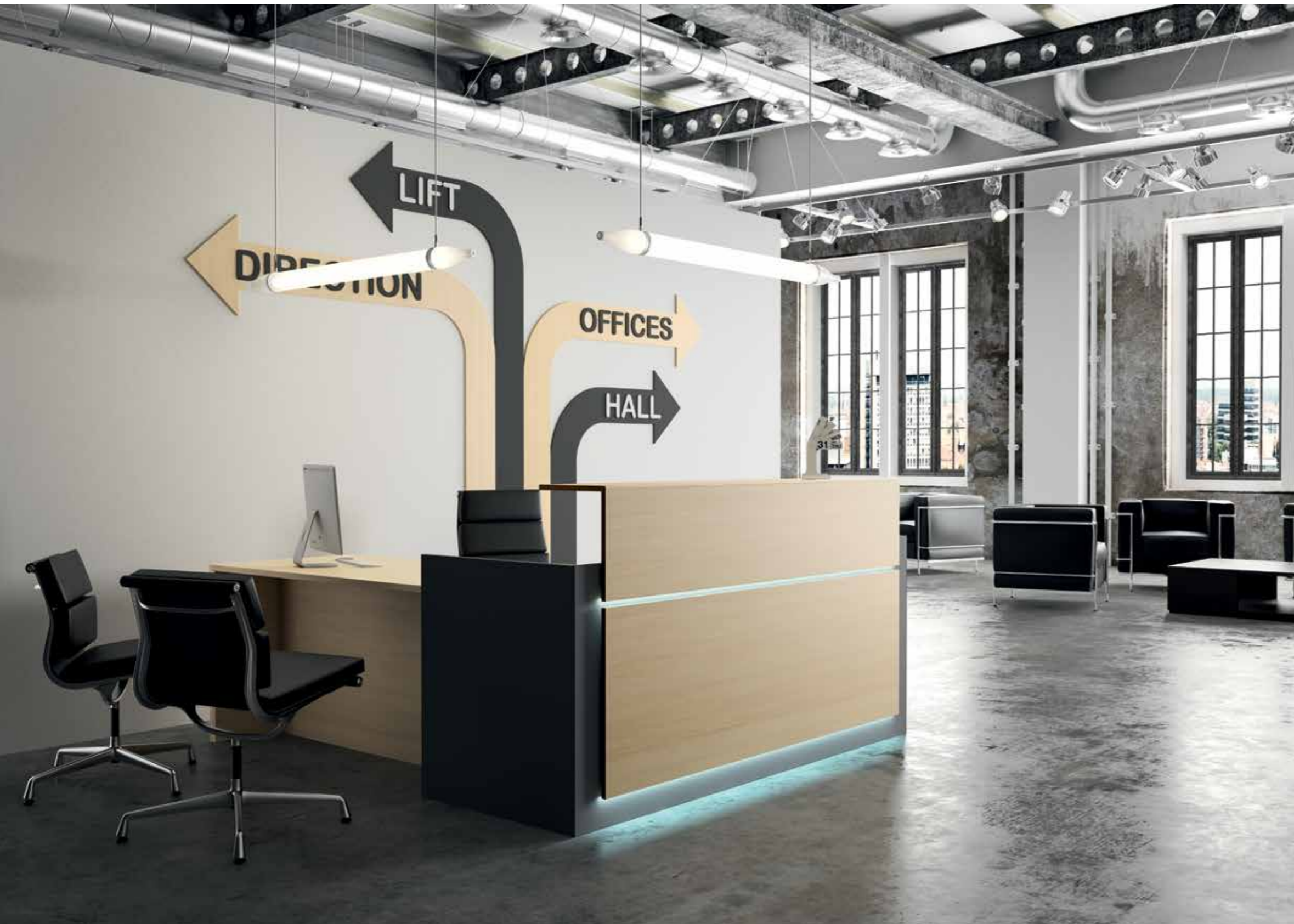

LAS DIFERENTES COMBINACIONES DISPONIBLES PERMITEN ESCOGER EL MOSTRADOR AVANT QUE MEJOR SE ADAPTE A SUS NECESIDADES. / THE STANDARD CONFIGURATIONS AVAILABLE ALLOW YOU TO CHOOSE, THE RECEPTION COUNTER WHICH BETTER MEETS YOUR REQUIREMENTS. LES DIFFÉRENTES COMBINAISONS DISPONIBLES VOUS PERMETTENT DE CHOISIR LE MODÈLE AVANT LE MIEUX ADAPTÉ À VOS BESOINS.



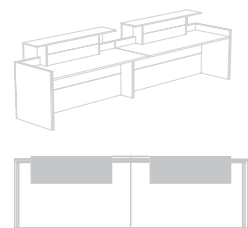



EL CONCEPTO MODULAR PERMITE CREAR MOSTRADORES DE MAYORES DIMENSIONES, EN FUNCIÓN DE LAS NECESIDADES Y EN EQUILIBRIO CON EL ESPACIO. RECEPCIONES PARA: HOTELES, TIENDAS, EDIFICIOS CORPORATIVOS, INSTITUCIONES... / THE MODULAR CONCEPT LETS CREATE RECEPTION COUNTERS OF LARGEST DIMENSIONS, DEPENDING ON THE REQUIREMENTS AND IN ACCORDANCE WITH THE SPACE. RECEPTIONS FOR: HOTELS, STORES, CORPORATE BUILDINGS AND INSTITUTIONS. / LE CONCEPT MODULAIRE PERMET DE CRÉER DES BANQUES D'ACCUEIL DE PLUS GRANDES DIMENSIONS, EN FONCTION DES BESOINS ET EN ÉQUILIBRE AVEC L'ESPACE EMPLACEMENT. RÉCEPTIONS POUR HÔTELS, MAGASINS, IMMEUBLES D'ENTREPRISE, INSTITUTIONS ...





AVANT OFRECE TAMBIÉN UNA MESA DESTINADA A SALONES DE ACTOS A ESPACIOS DE CONFERENCIAS. UNA PROPUESTA QUE OTORGA A LA SERIE AVANT LA POSIBILIDAD DE EQUIPAR DISTINTAS ÁREAS.

AVANT RANGE ALSO INCLUDES A PRESIDING TABLE FOR CONFERENCE AND MEETING ROOMS. WITH THIS PROPOSAL IT IS POSSIBLE TO EQUIP DIFFERENT SPACES WITH THE SAME STYLE.

AVANT PROPOSE ÉGALEMENT UNE TABLE POUR LES SALLES DE RÉUNION, LES SALLES DE CONFÉRENCE OU DE RÉUNION. UNE PROPOSITION QUI DONNE À LA SÉRIE AVANT LA POSSIBILITÉ D'ÉQUIPER DIFFÉRENTES ZONES.





ACCESORIOS DE ELECTRIFICACIÓN / ELECTRIFICATION ACCESSORIES/ ACCESSOIRES D'ELECTRIFICATION.



LAMPARA USB.
USB LAMP.
LAMPE USB.



CARGADOR DE INDUCCIÓN.
INDUCTION CHARGER.
CHARGEUR À INDUCTION.



POWER BOX / POWER BOX / POWER BOX.

POWER BOX / POWER BOX / POWER BOX.

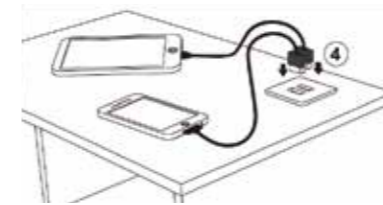

CARGADOR USB.
USB CHARGER.
CHARGEUR USB.



ACCESORIOS DE ELECTRIFICACIÓN.
ELECTRIFICATION ACCESSORIES.
ACCESSOIRES D'ELECTRIFICATION.



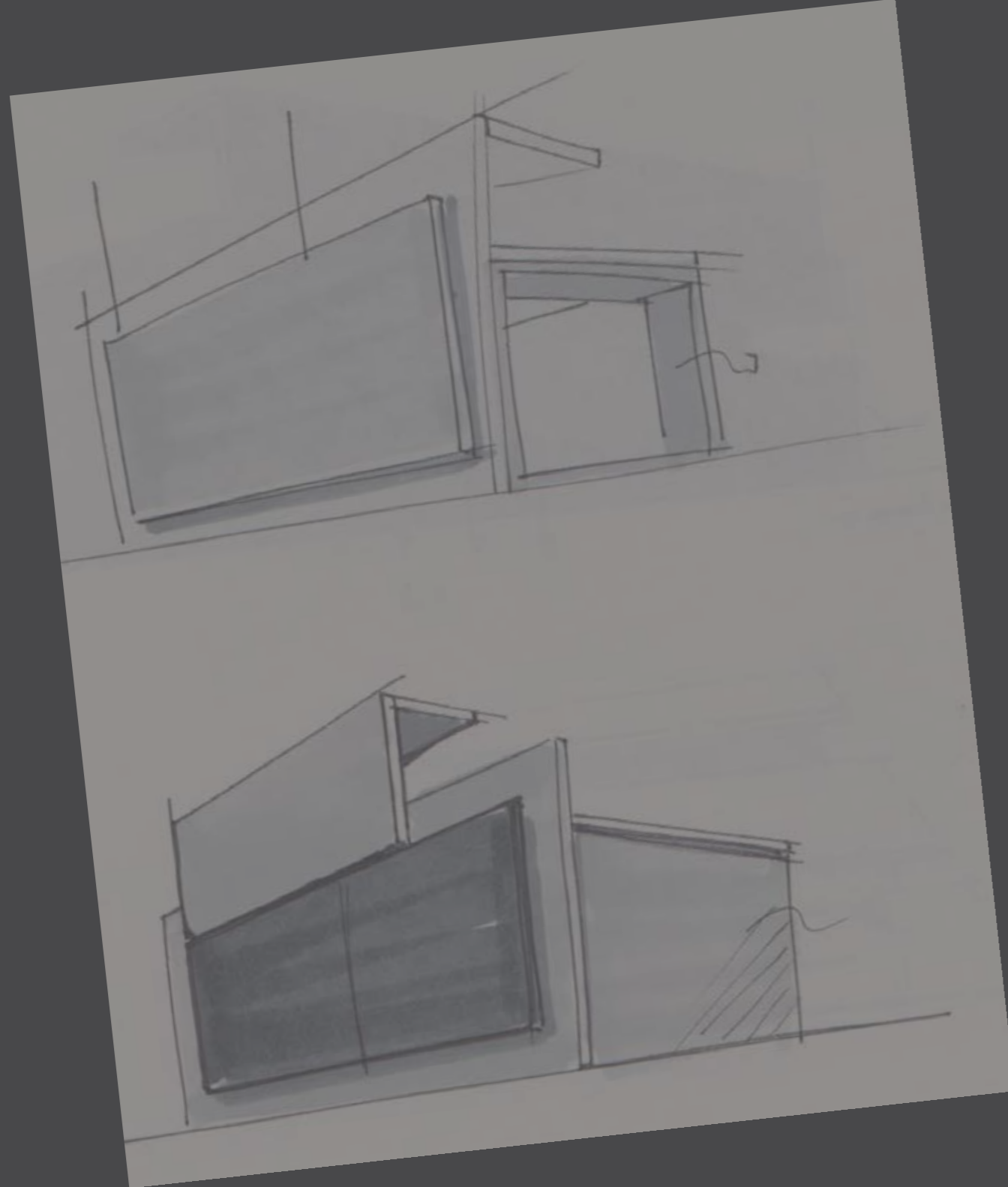

Mesa mostrador + interior mostrador
Reception counter /
Bureaux comptoir

DIMENSIONES CM
SIZE CM / DIMENSIONS CM
129 x 110 x 103
149 x 110 x 103
169 x 110 x 103
189 x 110 x 103

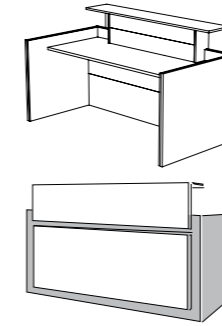

Mesa mostrador + interior estanteria
Reception counter + rayonnage /
Bureaux comptoir + Cabinet

DIMENSIONES CM
SIZE CM / DIMENSIONS CM
157 x 110 x 103
177 x 110 x 103
197 x 110 x 103
217 x 110 x 103

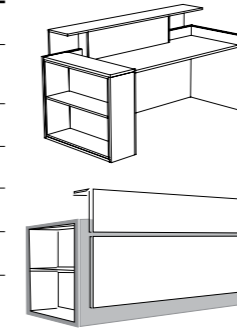

Mesa mostrador + atención personalizada frontal
Reception counter + frontal disabled reception /
Bureaux comptoir + attention personnalisée frontale

DIMENSIONES CM
SIZE CM / DIMENSIONS CM
238 x 110 x 78
258 x 110 x 78
278 x 110 x 78
298 x 110 x 78

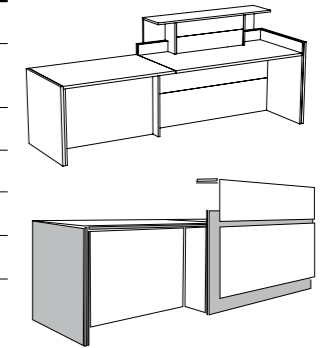

Mesa mostrador + atención personalizada lateral
Reception counter + lateral disabled reception counter /
Bureaux comptoir + comptoir attention personnalisée

DIMENSIONES CM
SIZE CM / DIMENSIONS CM
169 x 110 x 190
189 x 110 x 190

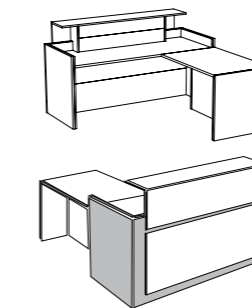

Mesa mostrador + extensión
Reception counter + 1 extension /
Bureaux comptoir + 1 prolongation

DIMENSIONES CM
SIZE CM / DIMENSIONS CM
249 x 110 x 103
289 x 110 x 103
329 x 110 x 103
369 x 110 x 103

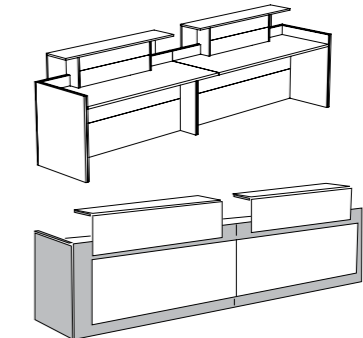

Extensión intermedia
Additional extension /
prolongation additionnel

DIMENSIONES CM
SIZE CM / DIMENSIONS CM
120 x 110 x 78
140 x 110 x 78
160 x 110 x 78
180 x 110 x 78

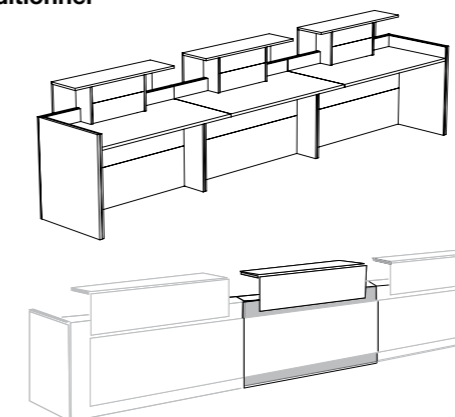

Mesa mostrador + interior mostrador
Presiding table /
Bureaux comptoir bas

DIMENSIONES CM
SIZE CM / DIMENSIONS CM
129 x 85 x 103
149 x 85 x 103
169 x 85 x 103
189 x 85 x 103

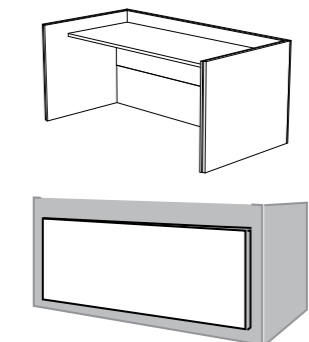



MOSTRADOR

NEW PANO

EL MOSTRADOR NEW PANO APORTA AMPLIAS SOLUCIONES CON TODOS LOS ACABADOS LUXE BY ALVIC DISPONIBLES.

THE NEW PANO COUNTER PROVIDES EXTENSIVE SOLUTIONS WITH ALL THE LUXE BY ALVIC FINISHES AVAILABLE.

LA BANQUE D'ACCUEIL NEW PANO FOURNIT DES SOLUTIONS COMPLÈTES AVEC TOUTES LES FINITIONS LUXE BY ALVIC DISPONIBLES.





MOSTRADOR NEW PANO

APORTA AMPLIAS SOLUCIONES PARA ESPACIOS DE RECEPCIÓN A PARTIR DE MÓDULOS INDIVIDUALES O DE PROGRESIÓN. PROGRAMA PARA MESAS PRESIDENCIALES.

RECEPTION DESK NEW PANO

BROAD SOLUTIONS FOR RECEPTION SPACES FROM INDIVIDUAL TO PROGRESSION MODULES. PROGRAMME FOR PRESIDENTIAL TABLES.

BANQUE D'ACCUEIL NEW PANO

VASTES SOLUTIONS POUR ESPACES D'ACCUEIL À PARTIR DE MODULES INDIVIDUELS OU DE PROGRESSION. PROGRAMME POUR TABLES PRÉSIDENTIELLES.





MESA MOSTRADOR / MESA PRESIDENCIAL P80.
RECEPTION DESK / PRESIDENTIAL TABLE P80.
BUREAU COMPTOIR / BUREAU PRÉSIDENTIELLE P80.

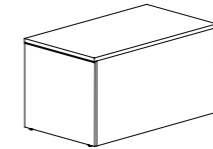

120 x 80 x 75
140 x 80 x 75
160 x 80 x 75
180 x 80 x 75

MESA AUXILIAR MOSTRADOR / MESA PRESIDENCIAL P60.
AUXILIARY RECEPTION DESK P60.
BUREAU COMPTOIR P60.

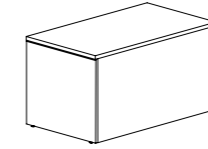

120 x 80 x 75
140 x 80 x 75
160 x 80 x 75
180 x 80 x 75

ALA MOSTRADOR.
RETURN RECEPTION DESK.
RETOUR ACCROCHÉ COMPTOIR.

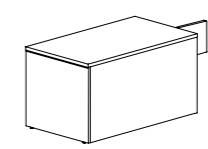

80 x 80 x 75
100 x 80 x 75
120 x 80 x 75

MESA DE ATENCIÓN PERSONALIZADA.
PERSONALISED ATTENTION PERSONNALISÉE.
COMPTOIR ATTENTION PERSONNALISÉE.

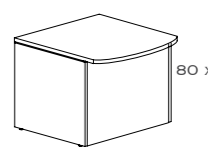

80 x 110 x 75

ALTILLO ARCHIVADOR MOSTRADOR.
FILING UNIT RECEPTION DESK.
MODULE REHAUSSE.

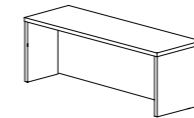

L 80 x 40 x 42,5
L 164 x 40 x 42,5

DIVISIÓN PARA ALTILLO ARCHIVADOR MOSTRADOR.
DIVISION FOR FILING UNIT RECEPTION DESK.
PANNEAU INTERMÉDIAIRE VERTICAL POUR REHAUSSE.

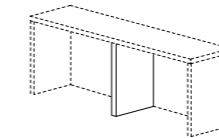

EJEMPLOS DE COMPOSICIÓN.
COMPOSITION EXAMPLES.
EXEMPLES D'AMÉNAGEMENT.

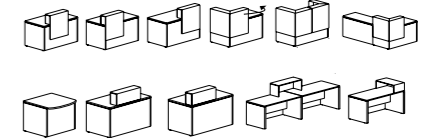

FRONTAL DECORATIVO
FRONT DECORATIVE RECEPTION DESK
FAÇADE DÉCORATIVE POUR COMPTOIR

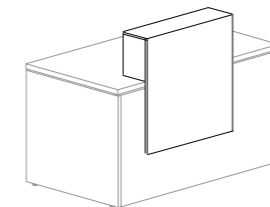

80 x 30 x 80
120 x 30 x 80

FRONTAL DECORATIVO 90°
DECORATIVE COUNTER FRONT 90°
FAÇADE DÉCORATIVE 90° POUR COMPTOIR

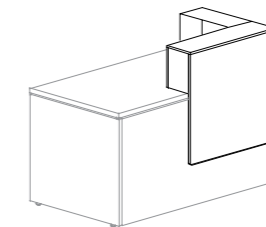

80 x 30 x 80

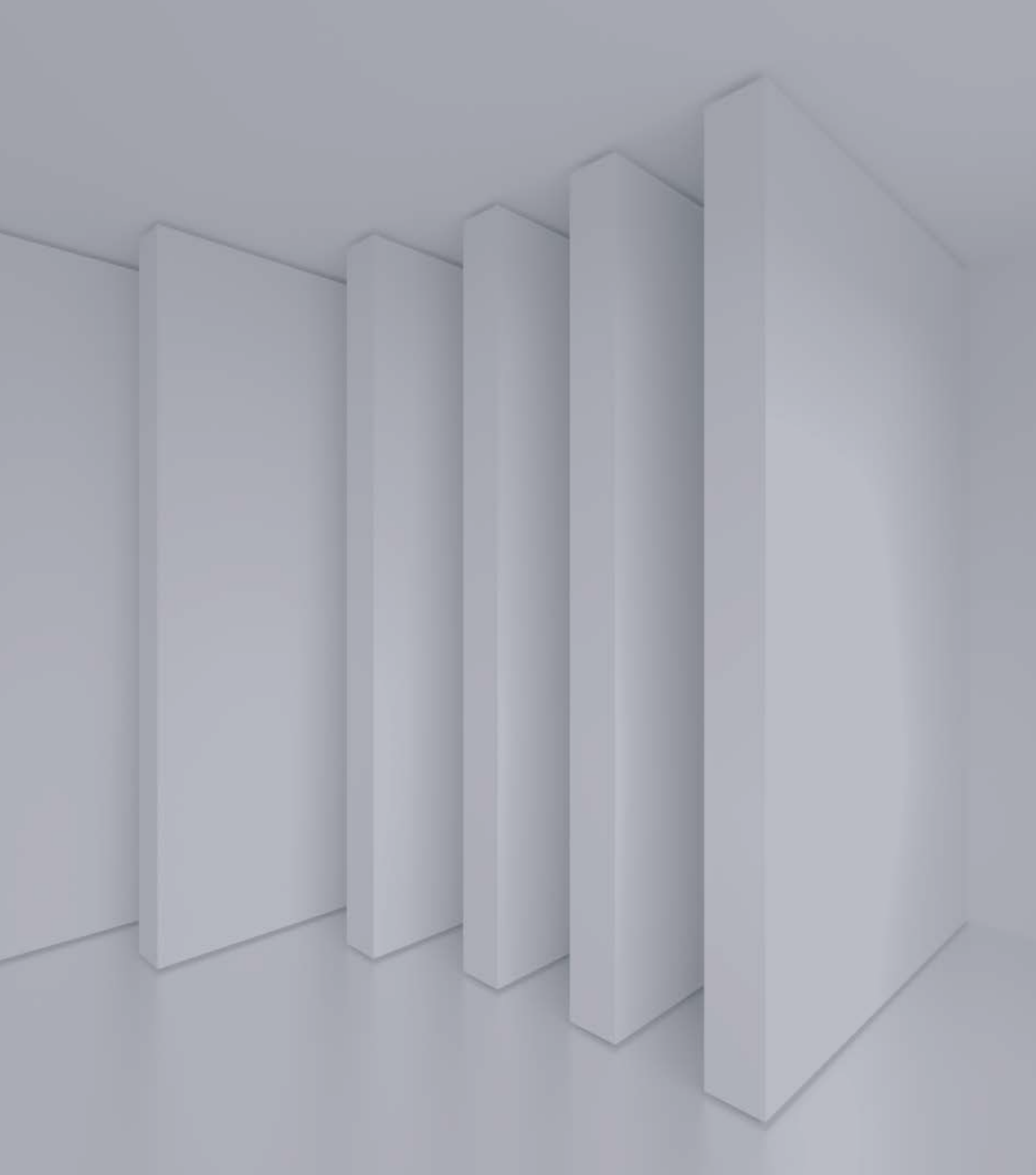

SISTEMAS DE ARCHIVO

NUESTRAS COLECCIONES DE SISTEMAS DE ARCHIVO, PERMITEN HACER COMBINACIONES CON TODOS NUESTROS ACABADOS DE ACUERDO CON NUESTRAS DIFERENTES GAMAS DE PRODUCTOS.

OUR ARCHIVING SYSTEMS COLLECTIONS ALLOWS TO MAKE COMBINATIONS WITH ALL OUR FINISHES ACCORDING TO OUR DIFFERENT PRODUCT RANGES.

NOS COLLECTIONS DE SYSTÈMES D'ARCHIVAGE PERMETTENT DE COMBINER TOUTES NOS FINITIONS SELON NOS DIFFÉRENTES GAMMES DE PRODUITS.

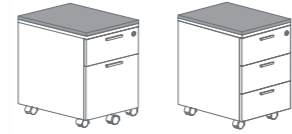

kubo 



Tendencies

Premier  



Monocolor

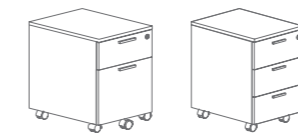

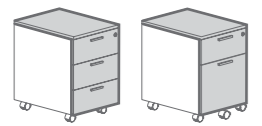

Tendencias



POSSIBILIDADE FERRAR OS LATERAIS DE LAS CAJONERAS.
POSSIBILITY TO COVER THE PEDESTAL SIDES.
POSSIBILITÉ DE COUVRIR LES CÔTÉS DES CAISSONS.

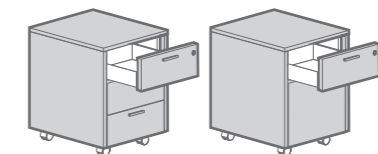

Tendencias



EL BUC ES IDEAL PARA LOS PUESTOS OPERATIVOS Y DIRECCIONALES. CON RUEDAS CON CAPACIDAD PARA UN USO PERSONAL Y DIARIO, CLASIFICAN MEDIANTE EL EMPLEO DE CAJONES O ARCHIVOS DE EXTRACCIÓN TOTAL Y FÁCIL ACCESO.

THE PEDESTAL IS IDEAL FOR MANAGEMENT AND OPERATIVE WORKSTATIONS. WITH WHEELS WITH CAPACITY FOR A PERSONAL AND DAILY USE, CLASSIFIED BY THE USE OF DRAWERS OR FILES OF TOTAL EXTRACTION AND EASY ACCESS.

LE CAISSON EST PARFAIT POUR LES POSTES DE TRAVAIL INDIVIDUELS ET DE DIRECTION. CAISSONS À ROULETTES POUR UN USAGE PERSONNEL ET QUOTIDIEN. CLASSEMENT À L'AIDE DE TIROIRS OU RANGEMENTS D'EXTRACTION TOTALE ET D'ACCÈS FACILE..



CON UN AMPLIO ABANICO DE ACABADOS TANTO PARA LOS FRENTES COMO PARA LOS ARMAZONES, BILAMINADOS O LUXES, HACEN QUE RESULTE UN ELEMENTO INDISPENSABLE EN EL AMUEBLAMIENTO DE UNA OFICINA.

WITH A WIDE RANGE OF FINISHES FOR FRONTS AND FRAMES, BILAMINATE OR LUXE, MAKE THE PRODUCT A NECESSARY ELEMENT FOR YOUR OFFICE.

SA LARGE GAMME DE FINITIONS POUR LES FAÇADES ET LES STRUCTURES, EN MÉLAMINÉ OU EN LUXE, EN FAIT UN ÉLÉMENT INDISPENSABLE POUR L'AMEUBLEMENT DE BUREAUX.



LAS CAJONERAS SON EL COMPLEMENTO IDEAL PARA LAS SALAS OPERATIVAS, YA QUE DOTAN A LOS PUESTOS DE TRABAJO DE TODO EL ESPACIO NECESARIO PARA LA CLASIFICACIÓN Y EL ALMACENAMIENTO DE DOCUMENTOS.

THE PEDESTALS ARE AN IDEAL COMPLEMENT FOR OPERATING ROOMS, SINCE THEY GIVE TO WORKSTATIONS ALL NECESSARY SPACE FOR DOCUMENT CLASSIFICATION AND DOCUMENT STORAGE.

LES CAISSONS SONT LE COMPLÉMENT IDÉAL POUR LES SALLES OPÉRATIONNELLES PUIS-QU'ILS CONFÈRENT AUX POSTES DE TRAVAIL TOUT L'ESPACE NÉCESSAIRE POUR LA CLASSIFICATION ET LE STOCKAGE DES DOCUMENTS.

colección - collection

premier

Cajonera.
Drawer mobile.
Caissons mobiles.

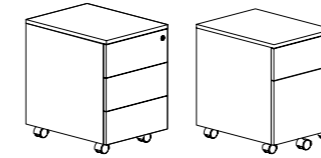

CM
42 X 55 X 55
42 X 55 X 55

Portalápices estándar
standard pencil tray
plumier standard

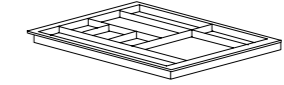

monocolor

Cajonera
Drawer mobile.
Caissons mobiles.

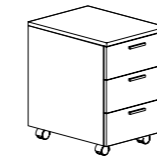

CM
42 X 55 X 60
42 X 55 X 60

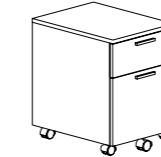

CM
42 X 55 X 60
42 X 55 X 60

Portalápices estándar
standard pencil tray
plumier standard

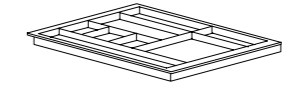

Portalápices estándar
Retractable pencil tray
plumier Télescopique

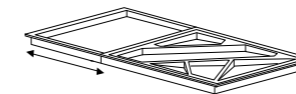

Tiradores adicionales
Additional handle
Poignée additionnelle

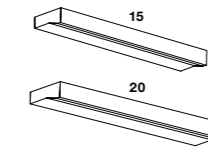

CM
16 X 2
15 X 2
20 X 2

Cierre amortiguado
Soft closing damper
Amortisseur fermeture

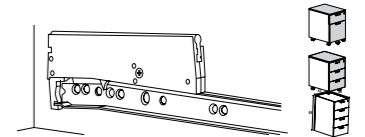

Tendencias

Cajonera
Drawer mobile.
Caissons mobiles.

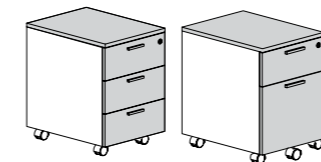

CM
42 X 55 X 60
42 X 55 X 60

Cajonera
Drawer mobile.
Caissons mobiles.

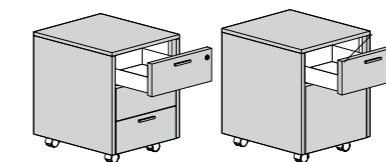

CM
46 X 55 X 60
46 X 55 X 60

Portalápices estándar
standard pencil tray
plumier standard

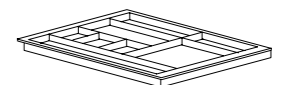

Portalápices estándar
Retractable pencil tray
plumier Télescopique

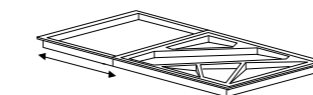

Tiradores adicionales
Additional handle
Poignée additionnelle

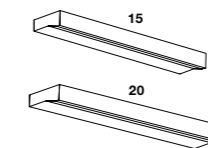

CM
16 X 2
15 X 2
20 X 2

Cierre amortiguado
Soft closing damper
Amortisseur fermeture

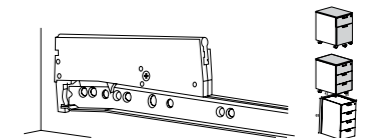

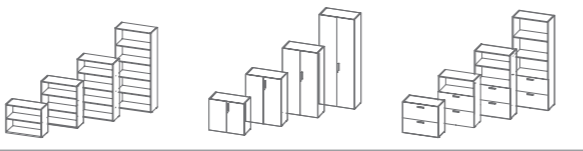
Premier 

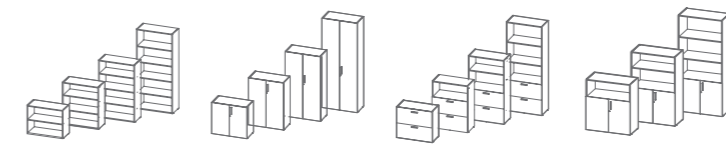

Tendencias



Kubo

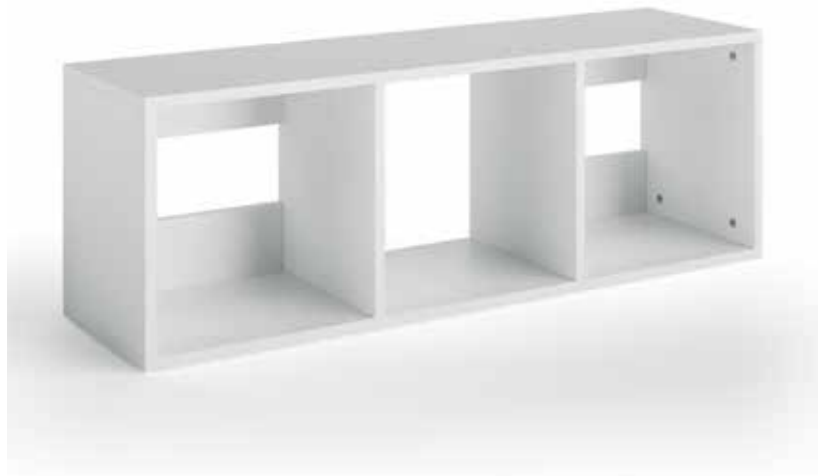



ARMARIOS DISPONIBLES EN UN AMPLIO ABANICO DE ACABADOS PARA PUERTAS Y ARMAZONES, DISPONEN DE UNA TRASERA DE 1 CM Y SU TECHO ESTRUCTURAL ES DECORATIVO AL MISMO TIEMPO. / OUR CABINETS ARE AVAILABLE IN A WIDE RANGE OF FINISHES FOR DOORS AND FRAMES. THE REAR PART IS PRODUCED IN 1CM AND ITS STRUCTURAL CEILING IS DECORATIVE AT THE SAME TIME. / LES ARMOIRES SONT DISPONIBLES DANS UN LARGE ÉVENTAIL DE FINITIONS DE PORTES ET DE CARCASSES. ELLES POSSÈDENT UN FOND DE 1CM D'ÉPAISSEUR ET LEURS TOPS STRUCTURELS EST EN MÊME TEMPS DÉCORATIF.

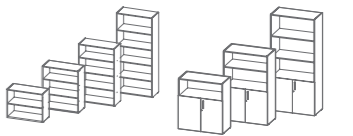
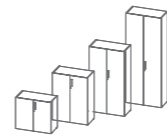





Tendencias 

DESARROLLO DE UN NUEVO SISTEMA DE ARMARIOS QUE PERMITEN SU PANELACIÓN. AMPLIA GAMA DE PANELES LATERALES, HORIZONTALES, SUPERIORES Y TRASEROS EN TODOS LOS ACABADOS PARA OFRECER UN ARMARIO PANELABLE COMPLETAMENTE. ESTABLE Y SÓLIDO, OFRECE UNA VARIEDAD DE ACABADOS INIGUALABLES.

WE HAVE DEVELOPED A NEW CABINET SYSTEM THAT ALLOW ITS PANELING. WIDE RANGE OF SIDE PANELS, HORIZONTAL, TOP AND BACK IN ALL FINISHES TO OFFER A COMPLETELY PANELABLE CABINET. STABLE AND SOLID, WE OFFER A BIG RANGE OF FINISHES UNMATCHED..

DÉVELOPPEMENT D'UN NOUVEAU SYSTÈME D'ARMOIRES QUI PEUVENT ÊTRE HABILLÉES. LARGE GAMME DE JOUES D'HABILLAGE LATÉRALES, HORIZONTALES, SUPÉRIEURES ET ARRIÈRES DANS TOUTES LES FINITIONS. STABLE ET SOLIDE, IL OFFRE UN ÉVENTAIL DE FINITIONS INÉGALÉ. .





ESTANTES REGULABLES A LO LARGO DE LA CREMALLERA. FABRICADOS CON MELAMINA DE 25 MM DE ESPESOR.

ADJUSTERS WITH HEIGHT REGULATION. MANUFACTURED WITH 25 MM THICK MELAMINE.

ÉTAGÈRES RÉGLABLES LE LONG DE LA CRÉMAILLÈRE. FABRIQUÉES EN MÉLAMINE, DE 25 MM D'ÉPAISSEUR.



POSIBILIDAD DE AÑADIR FORROS LATERALES Y TRASERAS A LOS ARMARIOS EN EL MISMO ACABADO QUE LAS PUERTAS O EN COMBINACIÓN CON OTROS ACABADOS. TRASERAS VISTAS.

POSSIBILITY TO ADD LATERAL SHELF PIN HOLES AND BACKS TO THE CABINETS IN THE SAME FINISHING AS THE DOORS OR COMBINING OTHER FINISHINGS.

POSSIBILITÉ D'AJOUTER DES PANNEAUX LATÉRAUX ET ARRIÈRE AUX ARMOIRES DANS LA MÊME FINITION QUE LES PORTES OU DANS D'AUTRES FINITIONS.



SISTEMA DE ARCHIVO CON CARPETEROS DEBAJO DE LAS ESTANTES (METÁLICOS).

ARCHIVING SYSTEM WITH FOLDERS UNDER THE METAL SHELVES.

SYSTÈME D'ARCHIVE AVEC DOSSIERS SUSPENDUS EN DESSOUS DES ÉTAGÈRES (MÉTALLIQUES).



BISAGRA REGULABLE EN HORIZONTAL Y EN VERTICAL.

ADJUSTABLE HINGE IN HORIZONTAL AND VERTICAL.

CHARNIÈRE RÉGLABLE EN HORIZONTAL ET VERTICAL.



TIRADORES EN ACABADO CROMADO Y ALUMINIO.

ALUMINIUM HANDLES.

POIGNÉES EN ALUMINIUM.

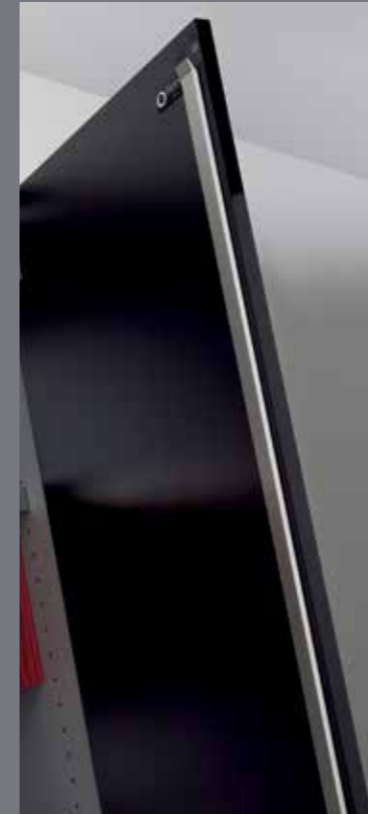

FALLEBA PLANA LINEAL QUE EVITA LA VIBRACIÓN DE LA PUERTA DISEÑO NOVEDOSO. ROD GUIDE. FLÉAU.



- DESARROLLO DE UN NUEVO SISTEMA DE ARMARIOS QUE PERMITEN SU PANELACIÓN.
- AMPLIA GAMA DE PANELES LATERALES, HORIZONTALES, SUPERIORES Y TRASEROS EN TODOS LOS ACABADOS PARA OFRECER UN ARMARIO PANELABLE COMPLETAMENTE.
- ESTABLE Y SÓLIDO, OFRECE UNA VARIEDAD DE ACABADOS INIGUALABLES, ILIMITADOS Y COMBINATORIAS.

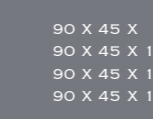
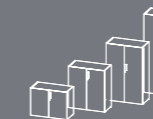

90 X 45 X 70
90 X 45 X 103
90 X 45 X 143
90 X 45 X 195



90 X 45 X 103
90 X 45 X 143
90 X 45 X 195



45 X 45 X 70
45 X 45 X 103
45 X 45 X 143
45 X 45 X 195



45 X 45 X 70 (D/I)
45 X 45 X 103 (D/I)
45 X 45 X 143 (D/I)
45 X 45 X 195 (D/I)



45 X 45 X 103 (D/I)
45 X 45 X 143 (D/I)
45 X 45 X 195 (D/I)



80 X 42 X 72



90 X 143



90 X 125



45 X 143



45 X 125



42 X 55 X 60
46 X 55 X 60



42 X 55 X 55



42 X 55 X 35



42 X 60 X 72
42 X 80 X 72



CERTIFICACIONES DE CALIDAD
CERTIFICATIONS DE QUALITÉ
QUALITY STANDARDS



AIDIMA
INSTITUTO TECNOLÓGICO
INDUSTRIAL, MINERAL, QUÍMICO Y AGRÍCOLA



PEFC/14-95-00047



ISO 9001
BUREAU VERITAS
Certification
N° 8001803



N° EMS 574207

ASOCIADOS
PARTENAIRES
PARTNERS



Made in Europe.



Grupo Alvic FR Mobiliario, S.L. Tavèrnoles 5, Pol. Ind. Malloles 08500 Vic - Barcelona - España.
T. (34) 93 889 25 02 F. (34) 93 889 11 57 www.ofitres.com pedidosofitres@grupoalvic.com